

VINOTEMP INTERNATIONAL







17631 SOUTH SUSANA ROAD
RANCHO DOMINGUEZ, CA 90221
(800)777.8466 FAX (310)886-3310

WINEMATE COOLING SYSTEMS

DIGITAL DISPLAY INSTRUCTIONS

WARNING:

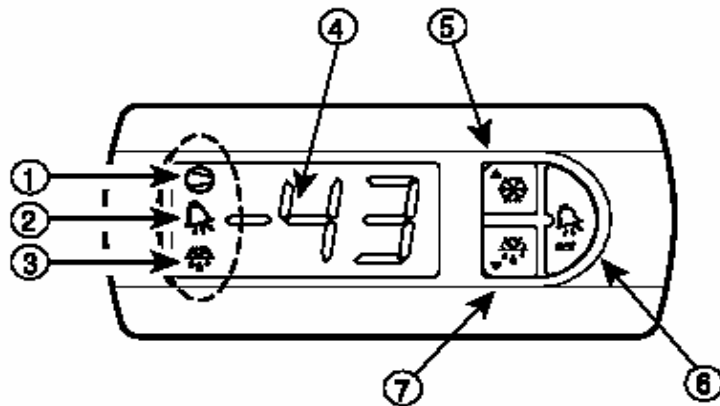

PLEASE DO NOT PLAY WITH THE DIGITAL DISPLAY
DO NOT PRESS ANY BUTTON FOR MORE THAN 60 SECONDS, IT WILL SHUT DOWN THE UNIT OR GO INTO SLEEP MODE.

- 1  The green LED indicates the **compressor is on** and running
- 2  **Alarm signal:** Indicates the alarm is on
- 3  **Defrost in progress:** LED will light when unit is in defrost mode
- 4 **Digital Display:** LED will display the temperature .
Codes will display on when pressed
- 5  LED button is to modify the temperatures
or activates/deactivates continuous cycle
Moves from one parameter to the next
Increases the value of the parameter
- 6  **Set Point:**
Silence the alarm
You will access the menu (if pressed for more than five seconds)
Blinking indicates that controller is waiting for a time delay to expired
- 7  LED button is to modify the temperatures
Moves from one parameter to the next
Decreases the value of the parameter



DURING NORMAL WORKING CONDITIONS, THE DISPLAY SHOWS THE VALUE MEASURED BY THE AIR. IN CASE OF AN ACTIVE ALARM, THE TEMPERATURE FLASHES ALTERNATELY TO THE CODE.





DEACTIVATE THE ALARM

Pressing the  button silences the buzzer and de-energizes the relay, while the alarm code and the red  LED go off only when the cause of the alarm no longer exist.
The alarm codes are shown below:

ALARMS AND SIGNALS

- E0** ERROR- PLEASE CALL or EMAIL **VINOTEMP**
- E1** ERROR- PLEASE CALL or EMAIL **VINOTEMP**
- IA** ERROR- PLEASE CALL or EMAIL **VINOTEMP**
- EE** ERROR- PLEASE CALL or EMAIL **VINOTEMP**
- d8** Alarm bypass time after defrost/door open
- HI** **FLASHING -HIGH TEMPERATURE ALARM**-The unit has read high temperature which is higher than the set point.
The alarm will automatically reset when the tempature returns within the set limit
- LO** **FLASHING- LOW TEMPERATURE ALARM**-The unit has read a low temperature which is lower than the set point
The alarm will automatically reset when the tempature returns within the set limit

SETTING THE SET POINT

- 1 Press the  button for one second to display the set-point value
- 2 After a few seconds , the set value blinks
- 3 Press up  or down  to increase or decrease the set point value
- 4 Press the  once/ more to confirm the new value

MAIN SINALS

dF - Defrost in progress

This is not a alarm signal, but rather an indication that the unit is in defrost mode
It will go into defrost mode every day for half an hour

Manual Defrost

Besides the automatic defrost, it is possible to activate a manual defrost by pressing  button for more than 5 seconds .

ps - Indicates the password

TROUBLE SHOOTING

1 **WINEMATE** COOLING SYSTEMS ARE SEALED SYSTEMS THAT REQUIRES A MINIMUM OF SERVICE.

WARNING:

UNPLUG UNIT BEFORE CLEANING

2 CLEAN THE EXHAUST GRILL AT LEAST 3-4 TIMES A YEAR.(RECOMMENDED WITH VACUUM)

3 THE UNIT MAY RUN CONSTANTLY OR CYCLE ON AND OFF FOR SHORT PERIODS.

4 THE TIME REQUIRED TO REACH THE DESIRED TEMPERATURE WILL VARY, DEPENDING ON THE ENCLOSURE CONSTRUCTIONS AND CONTENTS.

5 **WINEMATE** COOLING SYSTEM ARE NOT FOR USE BELOW 50°F. AND WORK BEST AT 55°F TO 60°F

PROBLEM	CHECK	REMEDY
NOT RUNNING	POWER TO OUTLET IS WINE CELLAR PLUGGED IN IS UNIT PLUG IN IS THERE DF DISPLAY ON DIGITAL CHECK FOR 15 MIN.& SEE IF UNIT ITS CYCLE WORKING NORMAL	RESET CIRCUIT BREAKER PLUG IN PLUG IN INSIDE OF WINE CELLAR UNIT IN DEFROST 30 MIN MAX
STILL DOES NOT START		CALL SERVICE
RUNNING WARM	UNIT TURNS ON ON OFF	ADJUST DIGITAL TO COLDER STTING
RUNS ALL THE TIME	IS CONDESOR DIRTY IS UNIT ICED UP PROPER CLEARANCE FROM WALL CHECK WINE CELLAR FOR AIR LEAKS	CLEAN CONDENSOR DEFROST AND CHECK FOR AIR FLOW OR ITS SET TO COLD EXHAUST 6" FROM WALL ALL AROUND REPAIR AIR LEAKS
STILL RUNS WARM		CALL SERVICE
RUNNING TO COLD	UNIT TURNS ON AND OFF	ADJUST DIGITAL TO WARMER SETTING
STILL RUNS TO COLD		CALL SERVICE
EXCESS MOISTURE IN WINE CELLAR	CHECK WINE CELLAR FOR AIR LEAKS AND DOORS SEALS	REPAIR AIR LEAKS OR SEAL DOORS

WINEMATE

WWW.WINE-MATE.COM

VINO-CD MODEL COOLING UNITS INSTALLATION INSTRUCTIONS

WINEMATE cooling units are designed to, when installed in a properly constructed cabinet or closet, provide a constant, selectable, temperature between 52-62F while maintaining 55-70% humidity. Products requiring these storage conditions include wine, furs, pastries, tobacco, chocolates and documents. WINEMATE cooling units are not intended to cool service cabinets which are maintained at lower temperatures and are opened frequently.

Before installing the unit in the enclosure, place it on a table and plug it into a properly grounded outlet. The thermostat has no off position, therefore it will run as soon as it is plugged in. allow it to run for approximately 15 minutes. There should be a flow of cool air from the bottom opening and warm air from the back. If you have any problems contact your dealer.

If your installation cannot be performed in accordance with these instructions contact your dealer. WINEMATE cooling units are not designed to have duct systems on either the exhaust or cold sides. Do not drill any holes into the cooling unit, it may damage the unit and will void the warranty.

INSTALLATION

Select a place to mount the unit where the exhaust air flow is unobstructed for a minimum of 3 feet. The area into which the unit exhausts must be well ventilated. If it is not heat exhausted by the unit will build up and the unit will not operate properly. Additionally, cold air from the bottom opening must remain unobstructed. The unit must be mounted near the ceiling and as close to equal distance from each end of the wall as possible.

Make a hole in the wall as illustrated in fig. 2. The dimensions of the hole should be 1/4 inch larger than the width and height of the unit. Construct a shelf as shown in fig. 3. This shelf must be capable of supporting the weight of the unit. Cut a 4 inch wide by 7 inch long hole for the cool air outlet. Place the unit on the shelf with the exhausted flush with the outside of the wall. Attach the exhaust grille to the wall with screws. Seal the opening with high quality weather stripping and cover with appropriate molding. Attach the molding to the wall not the unit. Plug the unit into a properly grounded outlet of adequate capacity.

Because of potential safety hazards under a certain condition we strongly recommend against the use of an extension cord. However, if you still elect to use an extension cord, it is absolutely necessary that it is a UL LISTED 3-wire grounding type appliance extension cord having a 3-blade grounding plug and a 3-slot receptacle that will plug into the appliance. The marked rating of the extension cord should be 115v, 15a. Or equivalent.

SPECIFICATIONS

WINEMATE	CAPACITY BTUH	DIMENSIONS IN.	ELECTRICAL	WEIGHT
VINO-1500CD	1500 BUTH	18 X 10.5 X 16.5	115V 60HZ 1PH 4A	50 LBS.
VINO-2500CD	2500 BTUH	18 X 10.5 X 16.5	115V 60HZ 1PH 5A	55 LBS.
GRILL		19.875 X 12.5		

On initial start-up the unit will reduce the temperature of the enclosure slowly. The unit may run constantly or cycle on and off for short periods. The time required to reach the desired temperature will vary, depending on the enclosure construction and contents. The thermostat is set for approximately 55f . Unless the temperature falls below that which is desired, do not change the thermostat for at least 3 days. After initial cool down, the on-off cycle should be relatively constant. The percentage of off time will depend on enclosure construction, contents and surrounding temperature.

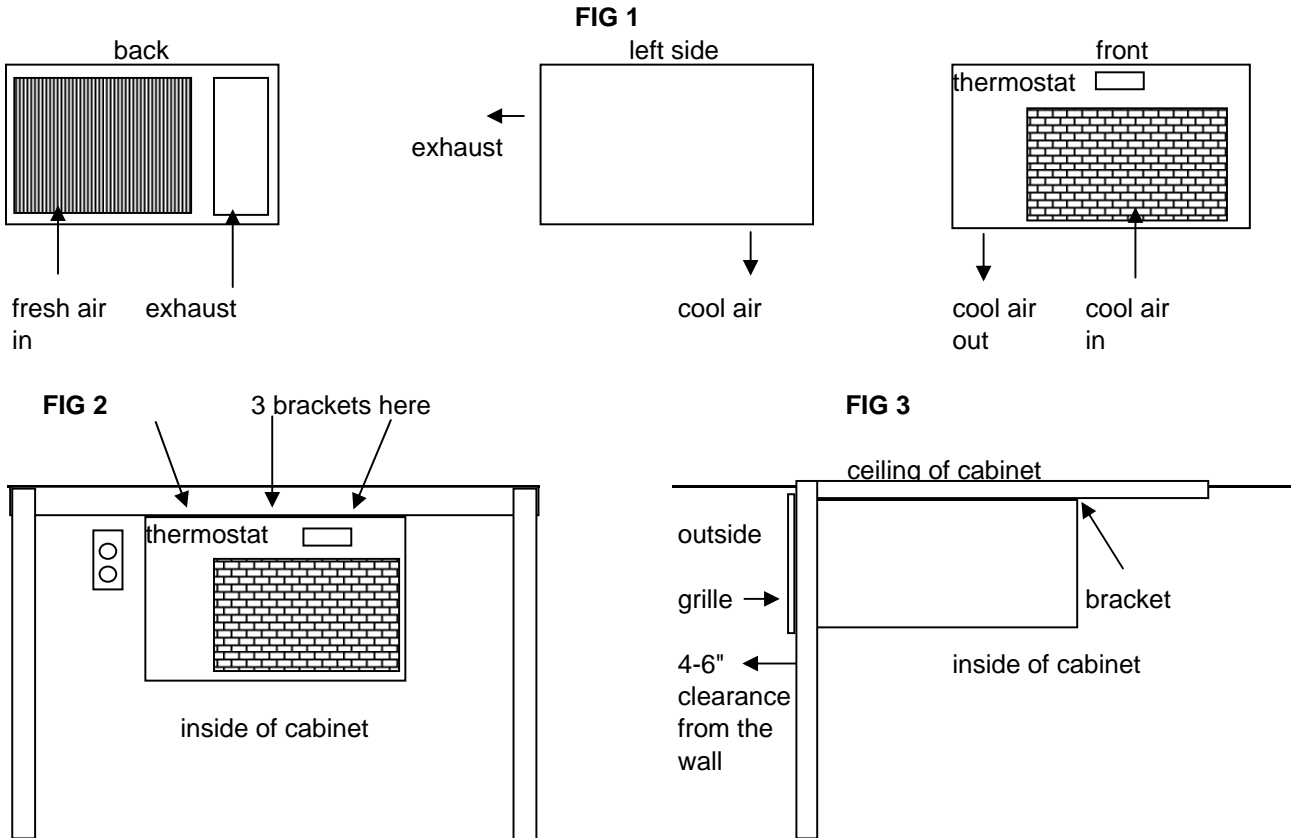

WINEMATE is extremely proud of the quality and reliability of its products. Experience has shown that of the small number of problems encountered, the large majority is due to improper unit selection or enclosure construction. Should the cooling system be suspected of malfunctioning, check the air being exhausted from the back of the unit. If it is warm then the unit is working. A further check may be done by comparing the temperature of the air entering the front of the unit with that leaving the bottom of the unit. If there is at least a 10 deg. difference, the unit is ok.

In some cases, improper placement or installation may cause the units performance to be degraded. The exhaust side of the unit must have a constant supply of fresh air. If the unit is exhausted into a confined space with poor ventilation, the unit will not be able to reject the heat it is removing from the enclosure and a malfunctioning unit will be suspected. Similar symptoms may be caused by an obstruction to the free air flow into or out of the unit.

Proper sealing of the enclosure cannot be over emphasized. The unit will not be able to maintain the proper conditions if fresh, moisture laden air is constantly being introduced in to the enclosure. Some symptoms of this condition are, the unit runs all the time with only a small reduction in temperature and or water over flows from the unit. Because of the temperature difference between the inside and outside very small cracks can allow large amounts of outside air into the enclosure.

Often a newly constructed room contains fresh wood, paint, concrete and other building materials that contain large amounts of moisture. When placed into operation in this type of environment, the unit may not be able to reject this excess moisture and can over flow. When the enclosure dries out this problem will stop.

WINEMATE

WWW.WINE-MATE.COM

LIMITED WARRANTY C AND HZ MODEL UNITS

WINEMATE warrants its products to be free from defects due to workmanship or materials under normal use and service, for twelve months after the initial sale. If the product is defective due to workmanship or materials, is removed within twelve (12) months of the initial sale and is returned to WINEMATE, in the original shipping carton, shipping prepaid, WINEMATE will at its option, repair or replace the product free of charge. Additionally WINEMATE warrants all parts to be free from defects for a period of sixty (60) months after initial sale.

This warranty constitutes the entire warranty of the WINEMATE COMPANY with respect to its products and is in lieu of all other warranties, express or implied, including any of fitness for a particular purpose. In no event shall WINEMATE COMPANY be responsible for any consequential damages what so ever. Any modification or unauthorized repair of WINEMATE products shall void this warranty.

SERVICE UNDER WARRANTY

This service is provided to customers within the continental UNITED STATES only.

WINEMATE cooling units are warranted to produce the stated number of BTUH. While every effort has been made to provide accurate guidelines, WINEMATE can not warranty its units to cool a particular enclosure.

In case of failure, WINEMATE cooling units must be repaired by the factory or its authorized agent. Repairs or modifications made by anyone else will void the warranty.

Should a WINEMATE cooling unit fail, contact the dealer for instructions. Do not return the unit to the factory without authorization from WINEMATE. If the unit requires repair, re-pack it in the original shipping carton and return it to the factory, shipping prepaid. WINEMATE will not accept COD shipments. If the unit is determined to be faulty and is within the twelve (12) month warranty period, WINEMATE will, at its discretion, repair or replace the unit and return it free of charge to the original retail customer. Additionally WINEMATE will, at standard shipping rates, reimburse the cost of returning the unit to the factory. If the unit is found to be in good working order, or beyond the initial twelve (12) month period, it will be returned freight collect.

Purchaser understands and acknowledges that the goods sold here are wine cellars, cigar humidors, and/or other similar units which house wine or cigars. Purchaser assumes all risk of using these units, including risk of spoilage, humidity variations, temperature variations, leaks, fire, water damage, mold, mildew, dryness and similar and any other perils that might occur.

LIMITATION OF IMPLIED WARRANTY

WINEMATE'S SOLE LIABILITY FOR ANY DEFECTIVE PRODUCT IS LIMITED TO, AT OUR OPTION, THE REPAIR OR REPLACEMENT OF UNIT.

WINEMATE SHALL NOT BE LIABLE FOR:

DAMAGE TO OTHER PROPERTY CAUSED BY ANY DEFECTS IN THE UNIT, DAMAGES BASED UPON INCONVENIENCE, LOSS OF USE OF THE UNIT, LOSS OF TIME OR COMMERCIAL LOSS.

ANY OUTER DAMAGES, WHETHER INCIDENTAL, CONSEQUENTIAL OR OTHERWISE.

THIS WARRANTY IS EXCLUSIVE AND IS IN LIEU OF ALL OTHER WARRANTIES, EXPRESSED OR IMPLIED, INCLUDING BUT NOT LIMITED TO, IMPLIED WARRANTIES OF MERCHANTABILITY OR FITNESS FOR A PARTICULAR PURPOSE.

While great effort has been made to provide accurate guidelines WINEMATE cannot warrant its units to properly cool a particular enclosure. Customers are cautioned that enclosure construction, unit location and many other factors can affect the operation and performance of the unit. There for suitability of the unit for a specific enclosure or application must be determined by the customer and cannot be warranted by WINEMATE.

VINOTEMP

WWW.VINOTEMP.COM

INSTRUCTIONS FOR WINE CELLAR INSTALLATION

Check shipping carton for any exterior damage before acceptance. Note any damage on the shipping document before signing. The trucking company's insurance covers damage by them.

Remove shipping carton and packing material (except pallet). Open the door and remove the plastic bag containing the casters/levelers. Tilt the cellar toward the back slightly and screw the front casters all the way in, then tilt the cellar toward the front and screw the back casters all the way in.

Remove the wooden pallet used for shipping (we recommend this be done with two people). If needed, adjust cellar by screwing casters back out as necessary to align the doors.

Move the cellar to the desired location. **Leave at least 6" between the back of the cellar and the wall. 3" for top exhaust units. These wine cellars are free standing units and are not designed to be built in.** The cellar is ready to plug into a 115v grounded outlet. We recommend a dedicated circuit but it is not essential. Extension cords are not recommended.

After plugging cellar in, open door to make sure the cooling unit is working. The cooling unit may not start if the room is below 65F. The duration of on and off periods will vary by the temperature and conditions of your environment. If you have any problems see the **TROUBLE SHOOTING CHART. IMPORTANT! do not attempt to open the cooling unit, any tampering with the cooling unit will void the warranty.**

The cooling unit is factory set for approximately 55F. The recommended aging temperature for both red and white wine is 53-57F. Close the door and allow the unit to run for 24 hours. If the temperature is too cold, turn the adjusting screw counter clock wise to make the unit warmer. If the temperature is too warm turn the screw clock wise to make it cooler. Make very small adjustments. Allow several hours for the unit to adapt after making a adjustment. **DO NOT TURN UNIT ALL THE WAY TO THE COLDEST POSITION, AS THIS WILL CAUSE THE UNIT TO ICE UP AND STOP COOLING.**

WINEMATE cooling units use the latest technology, which provides the maximum efficiency of cooling unit operation. **WINEMATE** units also use **ENVIRONMENTALLY SAFE R134A.**

LOADING; The wine cellar works most efficiently when loaded to capacity. The bottles act as a thermal mass, which stabilizes the temperature. To minimize handling and movement, we recommend you keep your most valuable wines in the double depth locations (close to the back wall). Begin loading your wines into the cellar starting from the bottom and moving up. The stacking space above the rack is for additional wine storage plus odd and large size bottles. do not place any bottles directly under the cold airflow from the cooling unit. As this could cause the unit to ice up.

VINOTEMP INTERNATIONAL

P.O. BOX 6107

COMPTON CA, 90221

PHONE; (310) 886-3332

FAX; (310) 886-3310

WINEMATE

WWW.WINE-MATE.COM

VINO1500 - 4500 HZD MODEL COOLING UNITS INSTALLATION INSTRUCTIONS

WINEMATE cooling units are designed to, when installed in a properly constructed enclosure or closet, provide a constant, selectable, temperature between 52-62F while maintaining 55-70% humidity. Products requiring these storage conditions include wine, furs, pastries, tobacco, chocolates and documents. WINEMATE cooling units are not intended to cool service cabinets which are maintained at lower temperatures and are opened frequently.

Before installing the unit in the enclosure, place it on a table and plug it into a properly grounded outlet. The thermostat has no off position, therefore it will run as soon as it is plugged in. allow it to run for approximately 15 minutes. There should be a flow of cool air from the front opening and warm air from the back.
any problems contact your dealer.

If your installation cannot be performed in accordance with these instructions contact your dealer. WINEMATE cooling units are not designed to have duct systems on either the exhaust or cold sides. Do not drill any holes into the cooling unit, it may damage the unit and will void the warranty.

INSTALLATION

Select a place to mount the unit where the exhaust air flow is unobstructed for a minimum of 3 feet. The area into which the unit exhausts must be well ventilated. If it is not heat exhausted by the unit it will build up and the unit will not operate properly. Additionally, cold air from the front opening must remain unobstructed. The unit should be mounted near the ceiling and as close to equal distance from each end of the wall as possible.

Make a hole in the wall as illustrated in fig. 2. The dimensions of the hole should be 1/4 inch larger than the width and height of the unit. Construct a shelf as shown in fig. 3. The shelf must be capable of supporting the weight of the unit. Place the unit on the shelf with the back of unit flush with the outside of the wall. Attach the grille to the outside wall with screws. Seal the inside with a high quality weather stripping and cover with molding. Attach the molding to the wall not the unit. Plug the unit into a properly grounded outlet of adequate capacity.

Because of potential safety hazards under a certain condition we strongly recommend against the use of an extension cord. However, if you still elect to use an extension cord, it is absolutely necessary that it is a UL LISTED 3-wire grounding type appliance extension cord having a 3-blade grounding plug and a 3-slot receptacle that will plug into the appliance. The marked rating of the extension cord should be 115v, 15a. Or equivalent.

SPECIFICATIONS

WINEMATE	CAPACITY BTUH	DIMENSIONS IN.	ELECTRICAL	WEIGHT
VINO-1500 HZD	1500 BTU	14.25 X13.25 X 16	115V 60HZ 1PH 4A	50 LBS.
VINO-2500 HZD	2500 BTU	14.25 X13.25 X 16	115V 60HZ 1PH 5A	55 LBS.
VINO-3500 HZD	3500 BTU	14.25 X 19.75 X 21.25	115V 60HZ 1PH 6A	90 LBS.
VINO-4500HZD	4500 BTU	14.25 X 19.75 X 21.25	115V 60HZ 1PH 8A	90 LBS.
GRILL	15-2500 HZ	15.625 X 14.625		
GRILL	35-4500 HZ	16.375 X 21.25		

OPERATION

On initial start-up the unit will reduce the temperature of the enclosure slowly. The unit may run constantly or cycle on and off for short periods. The time required to reach the desired temperature will vary, depending on the enclosure construction and contents. The thermostat is set for approximately 55f . Unless the temperature falls below that which is desired, do not change the thermostat for at least 3 days. After initial cool down, the on-off cycle should be relatively constant. The percentage of off time will depend on enclosure construction, contents and surrounding temperature.

If it is necessary to adjust the temperature of the enclosure, adjust to a colder temperature while the unit is running and to a warmer temperature while the unit is off. If the operation of the unit is stopped, either by unplugging it or by turning the thermostat, do not restart unit for at least 10 minutes.

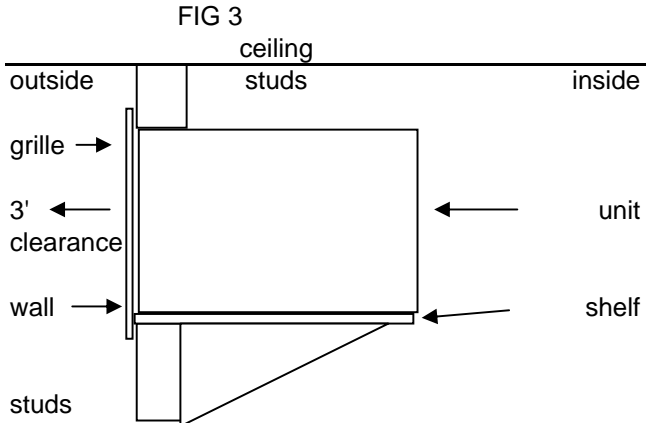
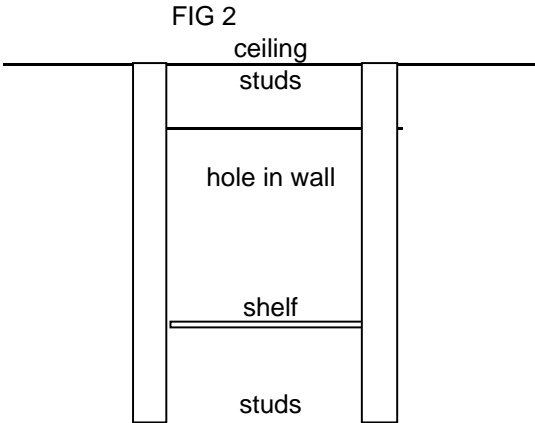
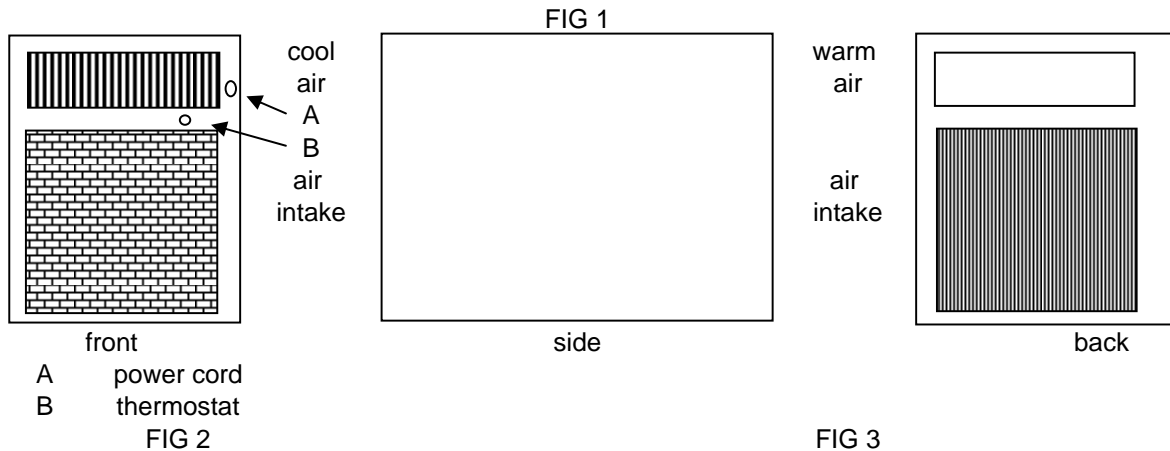

WINEMATE is extremely proud of the quality and reliability of its products. Experience has shown that of the small number of problems encountered, the large majority is due to improper unit selection or enclosure construction. Should the cooling system be suspected of malfunctioning, check the air being exhausted from the back of the unit. If it is warm then the unit is working. A further check may be done by comparing the temperature of the air entering the front of the unit with that leaving the front of the unit. If there is at least a 10 deg. difference, the unit is ok.

In some cases, improper placement or installation may cause the units performance to be degraded. The exhaust side of the unit must have a constant supply of fresh air. If the unit is exhausted into a confined space with poor ventilation, the unit will not be able to reject the heat it is removing from the enclosure and a malfunctioning unit will be suspected. Similar symptoms may be caused by an obstruction to the free air flow into or out of the unit.

Proper sealing of the enclosure cannot be over emphasized. The unit will not be able to maintain the proper conditions if fresh, moisture laden air is constantly being introduced in to the enclosure. Some symptoms of this condition are, the unit runs all the time with only a small reduction in temperature and or water over flows from the unit. Because of the temperature difference between the inside and outside very small cracks can allow large amounts of outside air into the enclosure.

Often a newly constructed room contains fresh wood, paint, concrete and other building materials that contain large amounts of moisture. When placed into operation in this type of environment, the unit may not be able to reject this excess moisture and can over flow. When the enclosure dries out this problem will stop.

WINEMATE

WWW.WINE-MATE.COMM

SPLIT SYSTEM

VINO-2500SS- V8500SS

INSTALLATION INSTRUCTIONS

Thank you for choosing WINEMATE for your cooling needs. Our cooling systems are designed to give years of trouble-free service, When properly installed. All WINEMATE cooling systems use ENVIRONMENTALLY FRIENDLY R134A.

WINEMATE cooling systems will provide a constant cooling temperature between 50f and 62f while reducing excess moisture when installed in a properly constructed enclosure. The system does not add moisture, and the system does not include heating.

Please take time to thoroughly read the instructions before installing the cooling system.

WARNING

Federal law requires that WINEMATE split cooling systems be installed by a EPA certified refrigeration technician.

NOTE

Before removing the cooling system from the box, inspect for damage which might have occurred during shipping. If any damage is found, notify the shipper immediately and file a claim.

INSTALLATION

WINEMATE split systems are shipped as components and are ready for use only after a certified refrigeration technician has properly installed and tested the system. Proper installation is critical. WINEMATE can only warrant the quality of the components. The installation and proper operation of the system must be warranted by the installer.

Installation of the system must be done in accordance with all state and local building codes. If your installation cannot be performed in accordance with these instructions contact your dealer.

WINEMATE cooling systems must be installed in the upright position and are not designed to have duct systems attached to them. Do not drill any holes into the unit. This may damage the unit, and WILL VOID THE WARRANTY.

WINEMATE split cooling systems are shipped as components, and are ready for use only after being properly installed and tested by a certified refrigeration technician.

The system consists of 2 parts, the FAN-COIL, and the CONDENSING UNIT.

The FAN-COIL includes the evaporator coil, thermal expansion valve, thermostat, liquid line solenoid, mounting brackets, drain line fitting, and fans.

The CONDENSING UNIT includes the condenser coil, compressor, low pressure control, service valves, and fans.

The FAN-COIL and CONDENSING UNIT are connected by a liquid line and a insulated suction line. Supplied by the installer. These lines must be properly sized for the distance between the units. Because of the control system we use there is no need for wiring between the units.

The FAN-COIL should be mounted against the ceiling of the enclosure using the bracket provided. The best location is centered in the enclosure. Be sure that the location is capable of supporting the weight of the unit. Air flow from the unit should be unobstructed for at least 1 foot. Provisions must be made for passing the line set through the wall to the CONDENSING UNIT.

The CONDENSING UNIT should be placed on a solid foundation with at least 1 foot clearance on all sides and 3 feet for exhaust air. Unit should be elevated to avoid possible flooding and shaded from direct sun. location should not be exposed to temperatures higher than 125f or lower than 20f. Unit must be wired in accordance with all state and local codes.

After the units and the lines are installed. The system must be pressure tested. If no leaks are found, evacuate the system. We recommend that the system be triple evacuated. using proper charging methods, charge system with R134A. Amount will vary depending on the length of line set.

MAINTENANCE

WINEMATE split systems require very little maintenance. The FAN-COIL should be KEPT clean. The CONDENSING UNIT should be inspected 3 to 4 times a year and the condenser cleaned as needed. Clean condenser by using a vacuum cleaner with a brush attachment, or use compressed air to blow dirt out of the unit.

If the condenser becomes blocked this will obstruct air flow, the unit will over heat causing a loss in cooling efficiency, and will result in compressor failure not covered by warranty.

OPERATION

On initial start-up the system will slowly reduce the temperature of the enclosure. The system may run constantly or cycle on and off frequently until the enclosure reaches the desired temperature. The time needed will very depending on size, contents, and construction. The thermostat is preset for approximately 55f. Unless the temperature falls below what is desired, do not change the setting for at least 3 days. After initial cool down the on-off cycle should be relatively constant.

SPECIFICATIONS

VINO-2500SS					
FAN COIL	2500BTU	R-134A	115V 60HZ 1A	ETL & NSF LISTED	35LBS
CONDENSING UNIT			115V 60HZ 5.7A	UL LISTED	40LBS
VINO-4500SS					
FAN COIL	4500BTU	R134A	115V 60HZ 1A	ETL & NSF LISTED	40LBS
CONDENSING UNIT			115V 60HZ 6.9A	UL LISTED	46LBS
VINO-6500SS					
FAN COIL	6500BTU	R134A	115V 60HZ 1.5A	ETL & NSF LISTED	90LBS
CONDENSING UNIT			115V 60HZ 12A	UL LISTED	66LBS
VINO-8500SS					
FAN COIL	8500BTU	R134A	115V 60HZ 5.2A	ETL & NSF LISTED	115 LBS.
CONDENSING UNIT		208-230V	60HZ 1PH 7.3A	UL LISTED	95LBS

LINE SET

				25'	50'	100'
VINO-2500SS	2500BTU	500CUFT	900 BOTTLES	3/8 X 1/2	3/8 X 1/2	3/8 X 1/2
VINO-4500SS	4500BTU	1000CUFT	4500 BOTTLES	3/8 X 1/2	3/8 X 1/2	3/8 X 5/8
VINO-6500SS	6500BTU	1500CUFT	6000 BOTTLES	3/8 X 1/2	3/8 X 5/8	3/8 X 5/8
VINO-8500SS	8500BTU	2000CUFT	10000 BOTTLES	3/8 X 5/8	3/8 X 5/8	3/8 x 7/8

FAN COIL

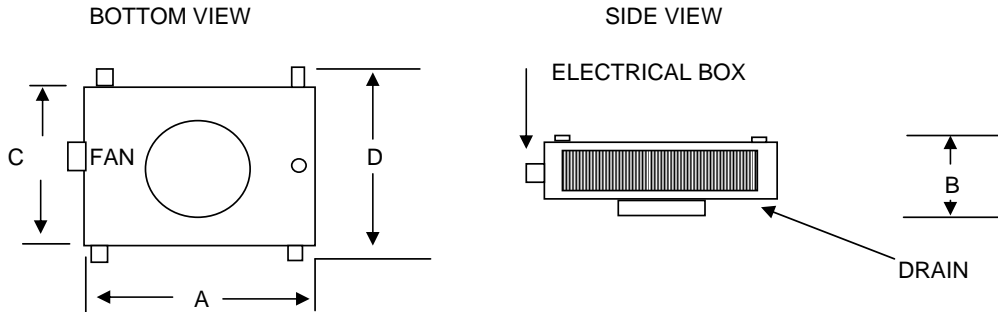

FAN COIL DIMENSIONS

	A	B	C	D	DRAIN
VINO-2500SS	17.5	7.5	20	21.5	3/8 OD
VINO-4500SS	17.5	10.5	20	21.5	3/8 OD
VINO-6500SS	21	11.75	29.875	30.375	3/4 MPT
VINO-8500SS	21	13.5	29.875	30.375	3/4 MPT

CONDENSING UNIT

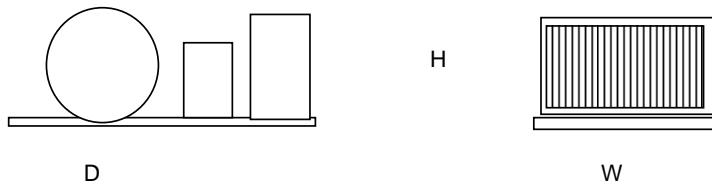

	W	H	D
VINO-2500SS	10.75	9.43	15.08
VINO-4500SS	10.75	9.43	15.08
VINO-6500SS	13	10.88	17.25
VINO-8500SS	14.6	13.75	18.5

OUT DOOR ENCLOSURE

25-4500 SS

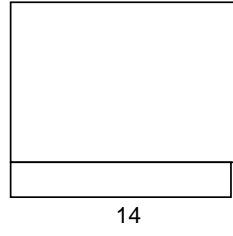

65-8500 SS

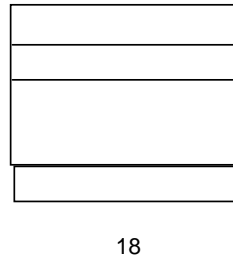

TYPICAL INSTALLATION

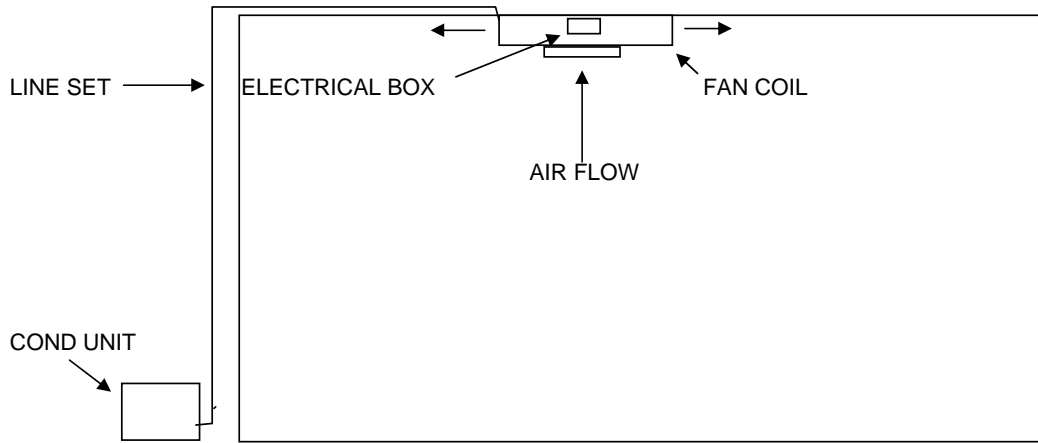

WINEMATE

WWW.WINE-MATE.COMM

VINO-1500 SS & 1900 SS SPLIT SYSTEMS

INSTALLATION INSTRUCTIONS

Thank you for choosing WINEMATE for your cooling needs. Our cooling systems are designed to give years of trouble-free service, When properly installed. All WINEMATE cooling systems use ENVIRONMENTALLY FRIENDLY R134A.

WINEMATE cooling systems will provide a constant cooling temperature between 50f and 62f while reducing excess moisture when installed in a properly constructed enclosure. The system does not add moisture, and the system does not include heating.

Please take time to thoroughly read the instructions before installing the cooling system.

WARNING

Federal law requires that WINEMATE split cooling systems be installed by a EPA certified refrigeration technician.

NOTE

Before removing the cooling system from the box, inspect for damage which might have occurred during shipping. If any damage is found, notify the shipper immediately and file a claim.

INSTALLATION

WINEMATE split systems are shipped as components and are ready for use only after a certified refrigeration technician has properly installed and tested the system. Proper installation is critical. WINEMATE can only warrant the quality of the components.

The installation and proper operation of the system must be warranted by the installer.

Installation of the system must be done in accordance with all state and local building codes. If your installation cannot be performed in accordance with these instructions contact your dealer.

WINEMATE cooling systems must be installed in the upright position and are not designed to have duct systems attached to them. Do not drill any holes into the unit. This may damage the unit, and WILL VOID THE WARRANTY.

WINEMATE split cooling systems are shipped as components, and are ready for use only after being properly installed and tested by a certified refrigeration technician.

The system consists of 2 parts, the FAN-COIL, and the CONDENSING UNIT.

The FAN-COIL includes the evaporator coil, thermal expansion valve, thermostat, liquid line solenoid, mounting brackets, drain line fitting, and fans.

The CONDENSING UNIT includes the condenser coil, compressor, low pressure control, service valves, and fans.

The FAN-COIL and CONDENSING UNIT are connected by a liquid line and a insulated suction line. Supplied by the installer. These lines must be properly sized for the distance between the units. Because of the control system we use there is no need for wiring between the units.

The FAN-COIL should be mounted inside of the enclosure using the bracket provided. The best location is centered in the enclosure. Be sure that the location is capable of supporting the weight of the unit. Air flow from the unit should be unobstructed for at least 1 foot. Provisions must be made for passing the line set thru the wall to the CONDENSING UNIT.

The CONDENSING UNIT should be placed on a solid foundation with at least 1 foot clearance on all sides and 3 feet for exhaust air. Unit should be elevated to avoid possible flooding and shaded from direct sun. location should not be exposed to temperatures higher than 125f or lower than 20f. Unit must be wired in accordance with all state and local codes.

After the units and the lines are installed. The system must be pressure tested. If no leaks are found, evacuate the system. We recommend that the system be triple evacuated. using proper charging methods, charge system with R134A. Amount will vary depending on the length of line set.

MAINTENANCE

WINEMATE split systems require very little maintenance. The FAN-COIL should be KEPT clean. The CONDENSING UNIT should be inspected 3 to 4 times a year and the condenser cleaned as needed. Clean condenser by using a vacuum cleaner with a brush attachment, or use compressed air to blow dirt out of the unit.

If the condenser becomes blocked this will obstruct air flow, the unit will over heat causing a loss in cooling efficiency, and will result in compressor failure not covered by warranty.

OPERATION

On initial start-up the system will slowly reduce the temperature of the enclosure. The system may run constantly or cycle on and off frequently until the enclosure reaches the desired temperature. The time needed will vary depending on size, contents, and construction. The thermostat is preset for approximately 55f. Unless the temperature falls below what is desired, do not change the setting for at least 3 days. After initial cool down the on-off cycle should be relatively constant.

SPECIFICATIONS

VINO-1500SS	150CUFT CEILING MOUNTED				
FANCOIL	1500BTU	R-134A	115V 60HZ .73A	ETL & NSF LISTED	15 LBS.
COND UNIT			115V 60HZ 3.1A	UL LISTED	30 LBS.
VINO-1900 SS	150CUFT WALL MOUNTED				
FANCOIL	1900 BTU	R-134A	115V 60HZ 2.2A	ETL & NSF LISTED	20 LBS.
COND UNIT			115V 60HZ 3.1A	UL LISTED	30 LBS.

LINE SET

VINO-1500 SS	25'	50'	100'
VINO-1900SS	3/8 X 1/2	3/8 X 1/2	3/8 X 1/2
	3/8 X 1/2	3/8 X 1/2	3/8 X 1/2

FAN COIL
VINO-1500SS

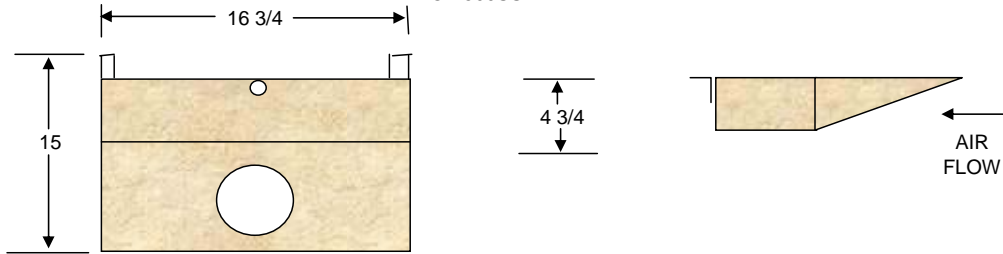

VINO-1900SS

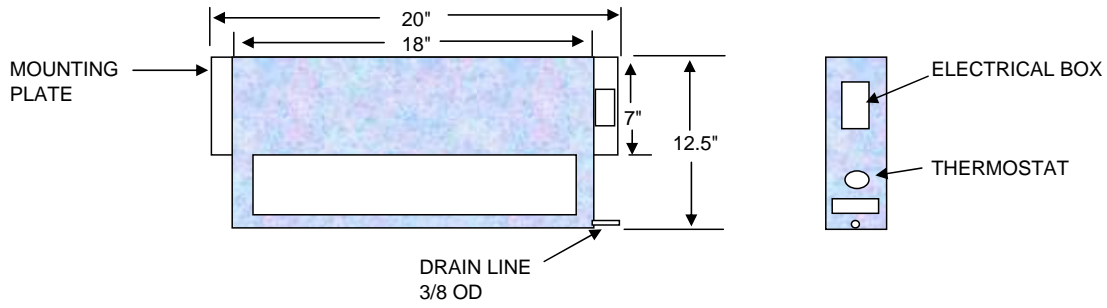

CONDENSING UNIT

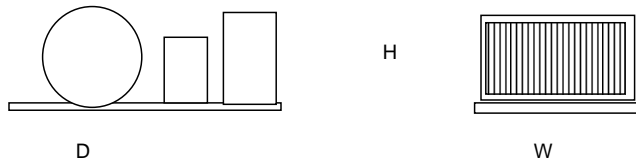

	W	H	D
VINO-1900 SS	10.75	9.43	15.08

OUT DOOR ENCLOSURE

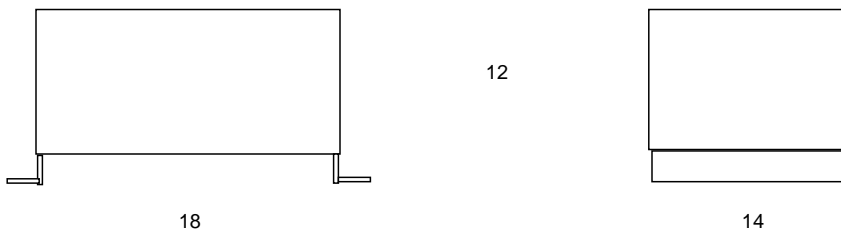

TYPICAL INSTALLATION

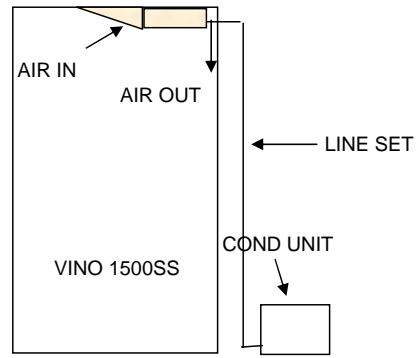
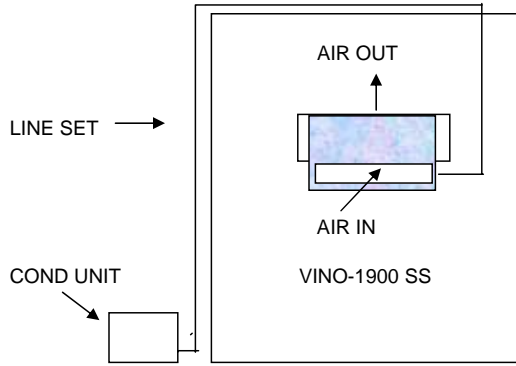

WINEMATE

WWW.WINE-MATE.COM

LIMITED WARRANTY

VINO-SS COOLING SYSTEMS

WINEMATE warrants this product to be free from defects in material and workmanship and agrees to replace any component found defective under these terms and conditions. This warranty may be enforced only by the original retail customer and is not transferable. All components used in this unit are warranted for ONE YEAR from the original retail purchase date.

Alteration, repair or attempted repair of the components by anyone not authorized by WINEMATE will void this warranty.

WINEMATE will cover the following:

During the first 12 months WINEMATE will pay for materials to replace the unit/components.

During the first 12 months WINEMATE will at the customers request, ship to the customer any replacement component with a deposit, charged at the value of the component, plus the freight. When the original component is returned in a condition that allows testing of the component and if that component is found to be defective, WINEMATE will refund the cost of the component and the freight.

To obtain warranty parts, WINEMATE may require you to provide the original bill of sale or receipt as proof of purchase. Please retain any such proof of purchase.

If a problem is suspected with a WINEMATE cooling unit contact your dealer. Do not return a unit/component without authorization from WINEMATE.

Should it be necessary to return a unit/component for warranty parts, it must be packaged in the original packaging or similar packaging providing an equal degree of protection. Any freight charges must be prepaid, WINEMATE will not accept collect shipments.

ITEMS NOT COVERED BY WARRANTY:

Any unit on which the serial number has been removed, modified or defaced.

Damage, deterioration or malfunction resulting from but not limited to:

Any shipment of the unit, claims for shipping damage must be presented to the shipper.

Installation or removal of the unit/component.

Installation into an enclosure of inadequate design that does not follow the minimum guide lines of the installation instructions.

Inadequate ventilation for the supply and exhausting condensers air that does not follow minimum guide lines of the installation instructions.

Accident, misuse, abuse, neglect, fire, water, lightning or other acts of nature, improper storage, unauthorized modification, electrical power surges, or failure to follow instructions supplied with unit.

Exposure to corrosive environments such as, but not limited to, marine air, pool chemicals, cleaning solvents, gasoline and petroleum products.

Burial or coverage by, but not limited to, dirt, snow, mud, storage shelves, fabric products, plants, and children's toys.

Any cause which does not relate to product defect.

WINEMATE WILL NOT PAY FOR:

Installation or removal of the unit/component.

Handling or packaging of the unit/component.

Component repairs performed by anyone other than a WINEMATE

Contents of enclosure

Any other damages, weather incidental, consequential or otherwise.

DATE	REV	DESCRIPTION	REVISIONS	DATE	APPROVED
------	-----	-------------	-----------	------	----------

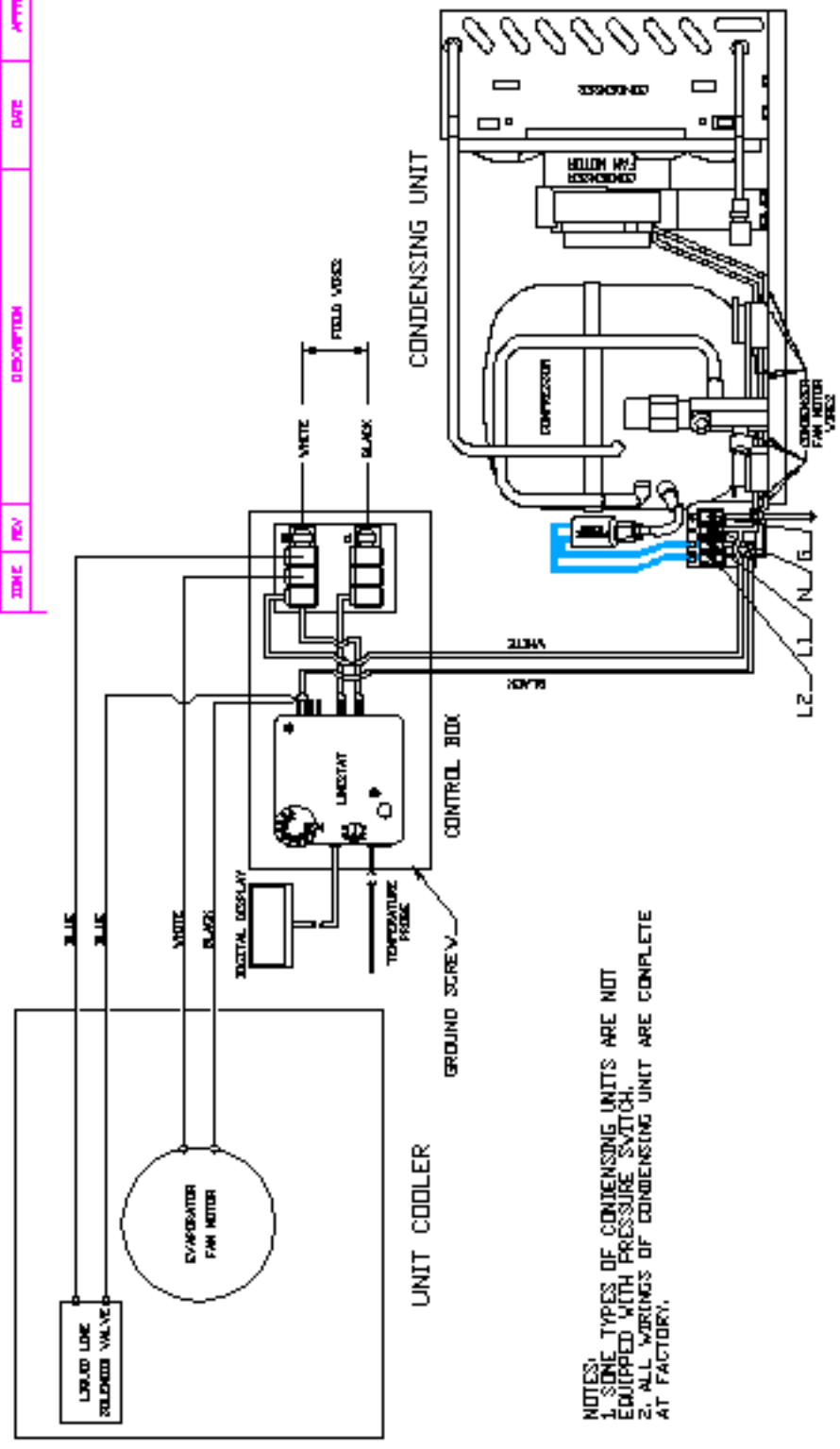

NOTES:
 1. SOME TYPES OF CONDENSING UNITS ARE NOT EQUIPPED WITH PRESSURE SWITCH.
 2. ALL WIRINGS OF CONDENSING UNIT ARE COMPLETE AT FACTORY.

BY		DATE	VINTECH INTERNATIONAL		
DWN		10/08-04-11	TITLE		
DWH			SPLIT SYSTEM WIRING DIAGRAM		
GJK			REV	FIG. NO.	DWG. NO.
APPY			A		VIND-00SS
MATERIAL			SCALE	3/8" NOT SCALE	SHEET 1 OF 1
FINISH					
QUANTITY					

WINEMATE SPLIT SYSTEMS

GENERAL DESCRIPTION- Split systems are remote type, forced air unit cooler, consisting of a direct expansion evaporator coil, evaporator fan (s) and motor (s), refrigerant distributors as needed, all rustproof aluminum housing, top mounting flanges for flush ceiling mount. The split system models are designed for application above freezing.

INSPECTION- Units must be inspected upon arrival. Any damage should be noted immediately and report to carrier and *WINEMATE*. It is the customer's responsibility to file all freight claims with the carrier.

HANDLING- All split systems should be uncrated and handled using the top as base- do not sit on its drain pan as the connections may be damaged .Use reasonable care to protect the unit handling shocks while the unit is being moved to its location.

LOCATING THE UNIT- Air supply should be unrestricted-as much as possible, choose an accessible area. The split system models should be located with equal air throw in each accessible area. The split system models should be located with equal air throw in each direction. Install the unit to frame members that are strong and level. The unit may be directly attached to the ceiling or may suspended on 5/16-rod hangers. Make sure the unit is absolutely level- the pan is already pitched for best drainage.

REFRIGERANT CONNECTIONS – Install all components of the refrigeration system in accordance with local and national codes and good practice for proper operation. We suggest that the refrigeration lines between the evaporator and remote condenser be no longer than 50 feet.

DRAIN – The drain line connected to the bottom connection of the drain pan should be pitched sharply and exit the room as quickly as possible.

WIRING – Split systems fan motors are connected in parallel- (2) leads are brought to the electrical junction box of the unit .All wiring should be done in accordance with local and national electric code. The unit cabinet must be grounded.

EXPANSION VALVES – It is important to recheck the expansion valve after the desired room temperature has been balanced at the desired temperature. To obtain the best coil performance with a uniform frost loading, set the proper superheat at the lowest temperature at which the system is expected to function. We recommend 6-8 degrees superheat for a 10-12 degrees TD system.

MAINTENANCE – The split system units are relatively simple and trouble free.

FAN MOTORS – The split system models, motors should be checked for oil level at three (3) month intervals. Use #20 non-detergent oil as needed. Motors are thermally protected. Motors are thermally protected. Motors are easily accessible. If a motor is not operating or cycle is on overload, disconnect the motor leads and apply rated voltage across the leads. If such motor does not operate well, it must be replaced. Fan motor may not operate properly when the coil is iced up.

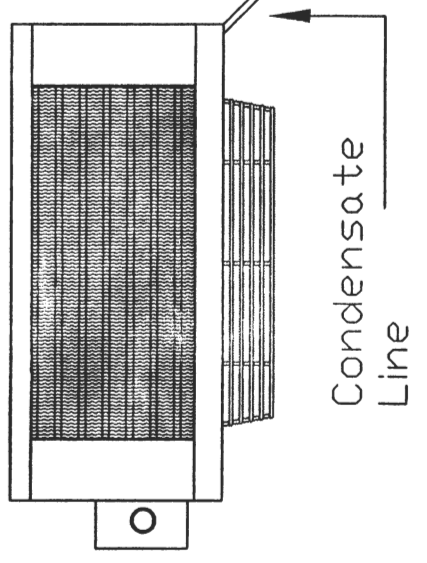
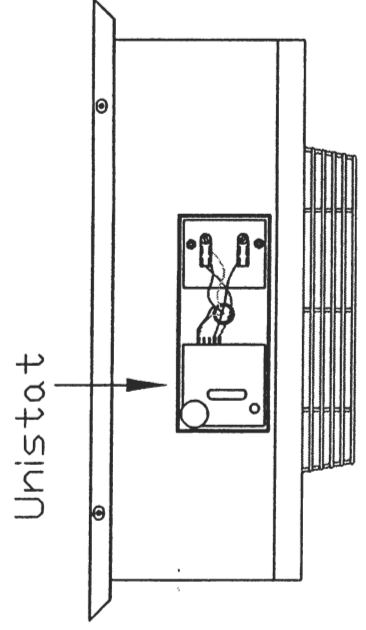
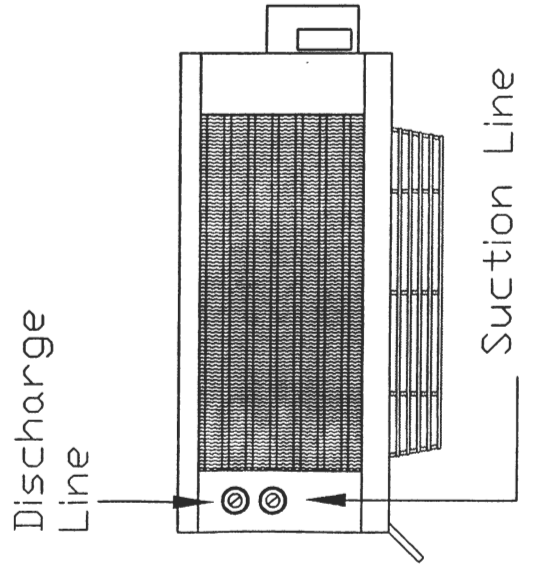
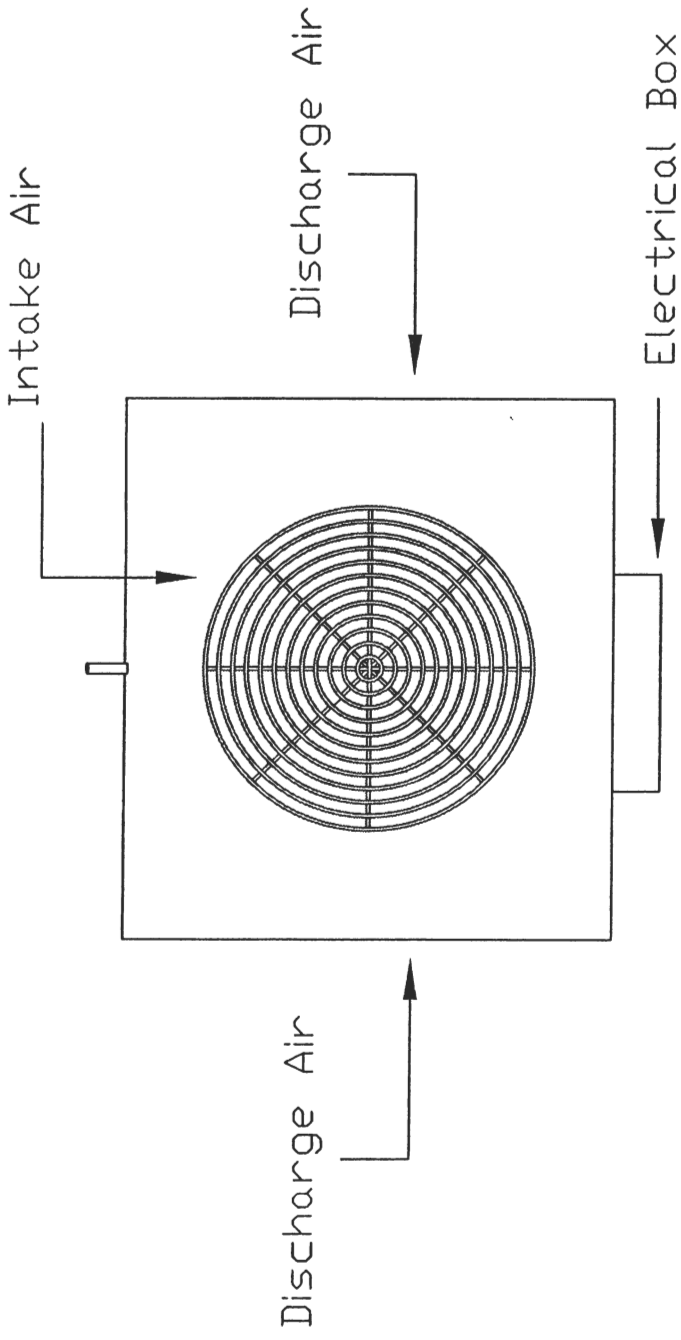

16 $\frac{3}{4}$

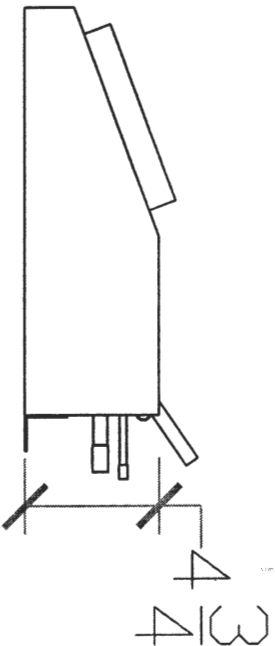
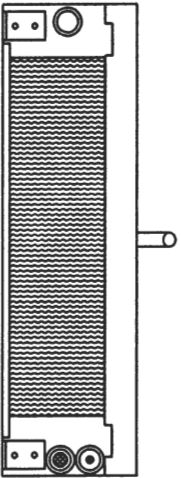
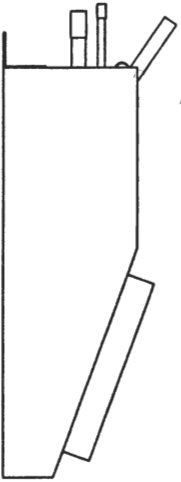
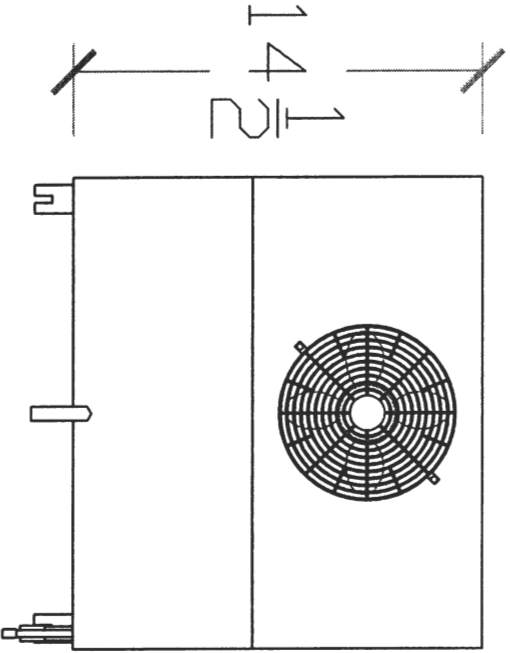

Item	Quantity	Title/Name, designation, material, dimension etc	Article No./Reference
Designed by Horacio	Checked by	Approved by - date	Date
Owner		Title/Name	Scale 1-1
Racks are shipped disassembled			Drawing number
Rev/d	Revision note	Date	Signature
		Checked	Edition
			Sheet

DIMENSIONS OF COOLING UNITS

VINO-1500CD	VINO-2500CD	VINO-2520CD	VINO-1500HZD
18Wx10.5Hx16D	18Wx10.5Hx16D	18Wx10.5Hx16D	14.25Wx12.25Hx16D
115V	115V	220V	115V
60HZ	60HZ	50HZ	60HZ
4 AMPS	5 AMPS	4 AMPS	4 AMPS
1/6HP	1/5 HP	1/5 HP	1/6HP
1500BTU	2500BTU	1800BTU	1500BTU
R134A	R134A	R134A	R134A
150CUFT MAX	250 CUFT MAX	200CUFT MAX	150 CUFT MAX
VINO-2500HZD	VINO-2520HZD	VINO-3500HZD	VINO-4500HZD
14.25Wx13.25Hx16D	14.25Wx13.25Hx16D	14.25Wx19.75Hx21.25D	14.25Wx19.75Hx21.25D
115V	220V	115V	115V
60HZ	50HZ	60HZ	60HZ
5 AMPS	4 AMPS	8 AMPS	9 AMPS
1/5 HP	1/5 HP	1/4 HP	1/3 HP
2500BTU	1800BTU	3500BTU	4500 BTU
R134A	R134A	R134A	R134A
250 CUFT MAX	200CUFT MAX	650 CUFT MAX	1000 CUFT MAX
VINO-4520HZD	VINO-6500HZD	VINO-8500HZD	
14.25Wx19.75Hx21.25D	17Wx22Hx28D	17Wx22Hx28D	
220V	115V	115V	
50HZ	60HZ	60HZ	
5 AMPS	14.2 AMPS	16 AMPS	
1/3 HP	1/2 HP	3/4HP	
3800BTU	6500BTU	8500BTU	
R134A	R134A	R134A	
850 CUFT MAX	1500 CUFT MAX	2000 CUFT MAX	

All **CD** and **HZD** cooling units use the Omni-Stat programmable controller features:

- Red light display
- Adjustable Temperature
- Adjustable Differential
- High and Low Temperature alarms
- Adjust defrost
- Time delay on stat

SPLIT SYSTEMS

VINO-1500SS

FAN COIL 16.75Wx4.75Hx15D ETL AND NSF LISTED
CEILING MOUNTED 115V 60HZ 73 AMPS

CONDENSING UNIT 14Wx12Hx18D UL LISTED
115V 60HZ 3.1 AMPS
1500BTU R134A
150 CUFT MAX

VINO-1900SSD

FAN COIL 18Wx12.5Hx4.5D ETL AND NSF LISTED
WALL MOUNTED 115V 60HZ 2.2 AMPS

CONDENSING UNIT 14Wx12Hx18D UL LISTED
115V 60HZ 3.1 AMPS
1500BTU R134A
150 CUFT MAX

VINO-2500SSD

FAN COIL 22Wx6Hx19.5D ETL AND NSF LISTED
CEILING MOUNTED 115V 60HZ 1 AMP

CONDENSING UNIT 14Wx12Hx18D UL LISTED
115V 60HZ 3.1 AMPS
2500BTU R134A
500CUFT MAX

VINO-4500SSD

FAN COIL 22Wx9Hx19.5D ETL AND NSF LISTED
CEILING MOUNTED 115V 60HZ 1 AMPS

CONDENSING UNIT 14Wx12Hx18D UL LISTED
115V 60HZ 6.9 AMPS
4500BTU R134A
1000 CUFT MAX

VINO-6500SSD

FAN COIL 30.75Wx11.75Hx23D ETL AND NSF LISTED
CEILING MOUNTED 115V 60HZ 1.5 AMPS

CONDENSING UNIT 18Wx14.5Hx24D UL LISTED
115V 60HZ 9.3 AMPS
6500BTU R134A

1500 CUFT MAX

VINO-8500SSD

FAN COIL 30.75Wx15.25Hx23D ETL AND NSF LISTED
CEILING MOUNTED 115V 60HZ 5.2 AMPS

CONDENSING UNIT 18Wx14.5Hx24D UL LISTED
 208.230V 60HZ 1PH 7.3 AMPS
 8500BTU R134A
 2000 CUFT MAX

All SSD unit use a mechanical thermostat adjustable from 45F TO 65F.

All SSD cooling system use the uni-stat electronics thermostat and timer features:

Green remote LED display
Adjustable Temperature
Adjustable differential
Adjustable defrost
Time delay on start

VT-HYDROMIST

HUMIDIFIER INSTRUCTIONS

The humidifier is designed to provide cool moist air for the humidor. By using a fan, a water reservoir and a humidistat. Install the humidifier in the bottom of the humidor. Connect the humidistat to the fan and mount it at the end of the wire above the humidifier. Fill the reservoir 3/4 full of water. Plug in humidistat. Cycle humidistat between highest and lowest setting at least 3 times to ensure proper function. Set control for desired humidity.

CHECK RESERVOIR REGULARLY. ADD WATER AND CLEAN RESERVOIR AS NEEDED.

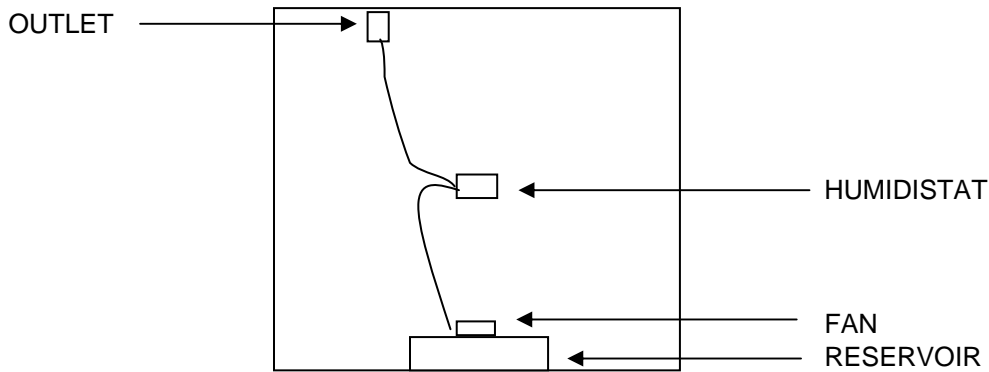

VT-HYDROMIST 1

RESERVOIR	16.5 X 6.5 X 5.5
CAPACITY	1 GALLON
HUMIDIFIES	90 CUBIC FEET

VT-HYDROMIST 2

RESERVOIR	12 X 6.5 X 5.5
CAPACITY	3/4 GALLON
HUMIDIFIES	48 CUBIC FEET

VT-HYDROMIST 3

RESERVOIR	6 X 6 X 5.5
CAPACITY	3/8 GALLON
HUMIDIFIES	26 CUBIC FEET

