

# Vinotemp®

A PROUD HERITAGE OF EXPERIENCE & QUALITY

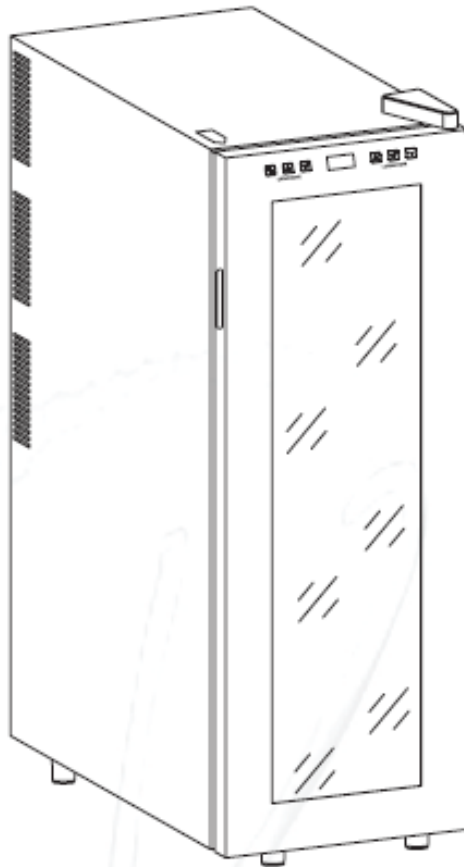

## WINE COOLER

VT-21TS-2Z

OWNER'S MANUAL

*Vinotemp®*

WWW.VINOTEMP.COM

## YOUR WINE CELLAR

This unit can be used for storage and/or service. The unit has seamless glass door and soft interior light to elegantly display your wine.

## SERVING WINES

Storing wines at the proper temperature is important. To preserve them as long as possible wine should be stored at approximately 55° Fahrenheit. However, the chart below suggests the optimal drinking temperature for the different styles of wine.

°C	°F	Wine Style
19	66	Armagnac, Brandy, Cognac
18	64	Full Bodied Red wines, Shiraz
17	62	Tawny Port
15	59	Medium Bodied Red Wines
14	57	Amontillado Sherry
13	55	Light Bodied Red Wines
12	54	Full Bodied White Wines
11	52	Medium Bodied White Wines
10	50	Rosé, Light Bodied White Wines
9	48	Vintage Sparkling
8	46	Fino Sherry
7	45	Non Vintage Sparkling

## **General Operating Instructions**

Remove all external and internal packaging from your wine cooler. Be sure that all parts have been included before discarding any packaging materials. You may want to keep the box and packing materials for use at a later date.

Upon receipt and inspection of unit, the supply cord must be replaced if it is damaged. Contact our customer service at 1-800-777-8466 or [info@vinotemp.com](mailto:info@vinotemp.com).

- Let the unit rest UNPLUGGED for 24 hours once you have it placed in your home.

**READ ALL INSTRUCTIONS BEFORE USING THIS APPLIANCE**  
**-Save these instructions-**

**To register your product, visit:**  
**<http://www.vinotemp.com/Warranty.aspx>**  
**Register your warranty within 10 days of receiving the unit.**  
**Please be sure to retain your proof of purchase.**

## TABLE OF CONTENTS

IMPORTANT SAFETY INSTRUCTIONS .....	5
ELECTRICAL CONNECTION .....	6
CIRCUIT DIAGRAM .....	6
PARTS & SPECIFICATIONS .....	7
TECHNICAL DATA.....	7
INSTALLATION.....	8
OPERATING YOUR WINE COOLER.....	8
CARE AND MAINTENANCE .....	9
PROBLEMS WITH YOUR WINE COOLER .....	10
TROUBLESHOOTING .....	10
TERMS OF SALE AND WARRANTY .....	11
SERVICE & IMPORTANT NOTICE.....	12



# IMPORTANT SAFETY INSTRUCTIONS



To reduce the risk of fire, electrical shock or injury when using your appliance, follow these basic precautions:

- Do not operate this or any other appliance with a damaged cord.
- Do not operate if housing is removed or damaged.
- Exercise caution and use reasonable supervision when appliance is used near children. Never allow children to operate, play with or crawl inside the appliance. Keep packing materials away from children.
- Before performing any maintenance or cleaning, ensure that the unit is unplugged or that the power line is disconnected.
- Do not clean appliance with flammable fluids. Do not store or use gasoline or other flammable vapors and liquids in the vicinity of this or any other appliance. The fumes can create a fire hazard or explosion.
- Exercise caution when moving and installing the unit. The cooler is heavy and may require two or more people when moving the unit to prevent strain or injury. Ensure that the wine cooler remains in the upright position during transportation.
- Never lift or carry the wine cooler by the cord.
- To ensure proper ventilation for your appliance, the front of the unit must be completely unobstructed. Choose a well-ventilated area with temperatures above 60°F and below 90°F.
- Locate the unit away from direct sunlight and sources of heat (stove, heater, radiator, etc). This unit is intended for indoor use only and must be installed in an area protected from the elements.
- Place the appliance on a solid, level surface.
- Do not place any other objects on top of the wine cooler.
- Do not attempt to repair or replace any part of your appliance unless it is specifically recommended in this manual. All other servicing should be referred to a qualified technician.
- Connect to properly polarized outlets only. It is recommended that a separate circuit, serving only your appliance be provided. Use receptacles that cannot be turned off by a switch or pull chain. Be sure that the plug is fully inserted into the receptacle.
- Use of an extension cord for the wine cooler is not recommended. Directly connect the wine cooler to an electrical outlet.
- To protect against electric shock, do not immerse appliance, plug or cord in water or other liquids. Avoid locating the unit in moist areas.
- This appliance is designed to be freestanding only.
- Do not use this appliance for anything other than its intended purpose. For freestanding, indoor, household use only. Any other use will void the warranty.
- Do not operate the unit with wet hands, while standing on a wet surface or while standing in water.
- Do not use solvent-based cleaning agents or abrasives on the interior of the cooler. These cleaners may damage or discolor the interior.
- Keep fingers out of pinch point areas and be careful when closing doors if children are around.
- This appliance is designed for storing and cooling wines. Do not store perishable food or medical products within the unit.
- To ensure proper internal air circulation, do not overfill the wine cooler.
- When disposing of refrigeration appliances, special handling is often required. It is the consumer's responsibility to comply with federal and local regulations when disposing of this product.
- **WARNING:** Risk of child entrapment and suffocation. Before you throw away this or an old unit, remove the door. Leave the shelves in place, so that children may not easily climb inside.

# ELECTRICAL CONNECTION



Improper use of the grounded plug can result in the risk of electrical shock. If the power cord is damaged, frayed or shows cracks or abrasions across its length, have it replaced at an authorized service center.

For your protection, this unit is equipped with a 3-conductor cord set that has a molded 3-prong grounding-type plug, and should be used in combination with a properly connected grounding-type outlet.

- Do not under any circumstances cut or remove the third ground prong from the power cord supplied. For personal safety, this appliance must be properly grounded.
- The cord should be secured behind the unit and not left exposed or dangling to prevent accidental injury.
- A standard electrical supply (110V AC only, 60Hz), properly grounded in accordance with the National Electrical Code and local codes and ordinances, is required.
- Never unplug the unit by pulling the power cord. To disconnect the appliance, always grip the plug firmly and pull straight out from the wall outlet. When moving the unit, be careful not to damage the power cord.
- The unit should always be plugged into its own individual electrical outlet with a voltage rating that matches the rating label on the unit.

## Extension Cord

**CAUTION:** It is strongly recommended that you do not use an adapter or an extension cord with this unit.

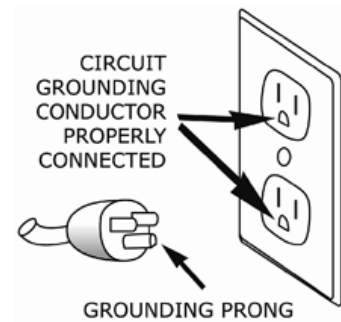

## CIRCUIT DIAGRAM

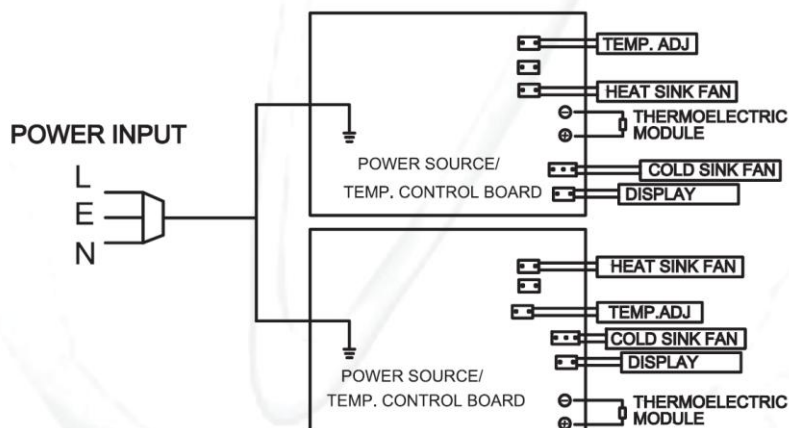

## PARTS & SPECIFICATIONS

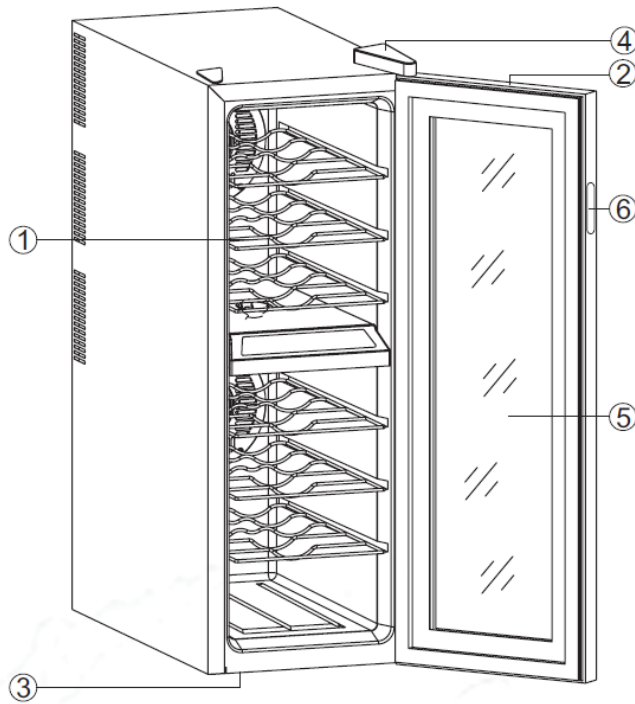

- |                  |                         |
|------------------|-------------------------|
| 1. Wire Shelf    | 4. Hinge Cover          |
| 2. Control Panel | 5. Stainless Steel Door |
| 3. Leveling Leg  | 6. Recessed Handle      |

## TECHNICAL DATA

Model no.	VT-21TS-2Z
Capacity	21 bottles*
Volume	65 liters
Voltage	AC 110V
Frequency	60 Hz
Input Power	130W
Power Consumption (kWh/24h)	1.5
Control Temperature Range	Upper Zone: 45° - 54° F Lower Zone: 54° - 64° F
Ambient Temperature Range	60° - 80° F
Approx. Net Weight	40.3 lbs
Approx. Gross Weight	59 lbs
Approx. Unit Size (W x H x D)	11 7/8" x 33 2/5" x 23 2/5"
Approx. Packing Size (W x H x D)	15 3/5" x 35 3/5" x 27 1/5"

\*Note: This wine cooler is designed to store up to 21 standard Bordeaux 750 ml bottles. Storing large and/or oddly shaped bottles (including champagne and sparkling wine bottles) will decrease the capacity of your wine cooler.

# INSTALLATION

- Remove all packing material before using your wine cooler. Check to be sure all parts are included and that the cooler is in good condition.
- **IMPORTANT:** Before connecting the unit to a power source, let it stand upright for approximately 24 hours. This will reduce the possibility of a malfunction in the cooling system from handling during transportation.
- Clean the interior surface with lukewarm water and a soft cloth.
- This unit is designed for freestanding installation and indoor use only. Position the unit in a dry and well-ventilated place. Avoid placing the wine cooler near any source of heat or moisture, or in direct sunlight. Do NOT install the unit in a location with an ambient temperature that will fall below 60°F.
- When positioning the cooler, 6 inches of space at the back and 10-12 inches of space both sides are suggested to ensure proper air circulation to cool the cooling system. There also must be unlimited clearance at the top of the cooler to ensure proper air circulation.
- The unit is designed for freestanding installation only. It is not designed to be installed under a counter, inside a cabinet, or in any location that does not allow the proper clearances on all sides, as stated above.
- Place the wine cooler on a solid, level surface strong enough to support it when it is fully loaded. To level the wine cooler, adjust the front leveling legs at the bottom of the wine cooler. To ensure vibration and noise-free operation, do not install on carpet.
- For best performance it is recommended that you install the appliance in a location with an ambient temperature between 60°-80°F. If the ambient temperature is above or below recommended temperatures, the performance of the unit may be affected.
- Plug the wine cooler into an exclusive, properly installed-grounded wall outlet.
- Upon plugging the cooler into an electrical outlet, let the unit run for at least 30 minutes before making any adjustments.

## OPERATING YOUR WINE COOLER

The wine cooler has an electric temperature control panel and two temperature zones. When first turned on, the LED display will show the ambient temperature, followed by the internal cabinet temperature.

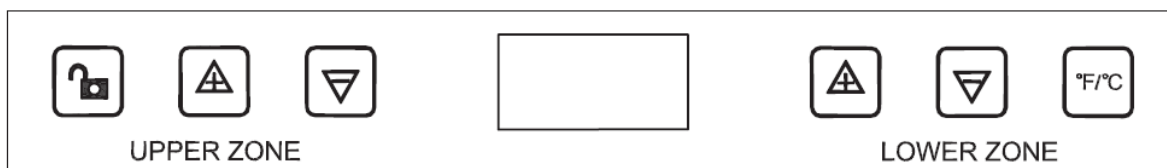

### UP ▲

Used to raise (warm) the corresponding zone set temperature by 1°C or 1°F.

### DOWN ▼

Used to lower (cool) the corresponding zone set temperature by 1°C or 1°F.

### °F/°C Selector

Used to select the temperature display setting in degrees Fahrenheit or degrees Celsius. To change the temperature from Fahrenheit to Celsius or from Celsius to Fahrenheit, touch this button.

### CONTROL PANEL LOCK 🔒



Used to lock or unlock the control panel.



## LIGHT

To turn the light on and/or off, press the interior light button.

## SETTING A TEMPERATURE

- The interior control range is 45°- 64°F
- The lower zone temperature can be set between 54° and 64°F, and the upper zone temperature can be set between 45° and 54°F.
- The temperature will increase by 1°C or 1°F if you touch **UP**  once, or the temperature will decrease by 1°C or 1°F if you touch **DOWN**  once.
- Upon choosing your desired temperature, the display will flash the selected temperature setting for 5 seconds before reflecting the current internal cabinet temperature.

## STORING WINE

While bottles may vary in size and dimension, approximately 21 standard bottles (750ml, 12" in length and 3" in diameter) can be stored in your wine cooler. Please note that bottle capacities are approximate maximums when storing traditional Bordeaux 750 ML bottles and include bulk storage. Actual number of bottles you are able to store may vary.

# CARE AND MAINTENANCE

## CLEANING YOUR WINE COOLER

**IMPORTANT:** Always unplug the unit before cleaning or performing maintenance. Never use harsh cleansers or scouring pads to clean any part of the unit.

- Turn off the power, unplug the appliance, and remove all items including shelves.
- Wash the inside surfaces with a warm water and baking soda solution. The solution should be about 2 tablespoons of baking soda to a quart of water. Do not use abrasive cleaners.
- Wring excess water out of the sponge or cloth before cleaning control panels or any electrical parts.
- Wash the outside cabinet with warm water and mild liquid detergent. Rinse well and wipe dry with a clean soft cloth. Clean the back and bottom of the wine cooler thoroughly to ensure efficient operation.
- Wipe dry with a soft cloth. Dry all surfaces before use.

## MOVING YOUR WINE COOLER

Before moving your wine cooler, first be sure to remove all items from the cooler.

- Securely tape down any loose items, such as shelves, inside the unit.
- Turn the levelling legs up to the base to avoid damage.
- Tape the door shut.
- Ensure that the unit stays securely in the upright position during transportation. Protect the outside of the appliance with a blanket or similar item.

## INACTIVITY

If the unit will be used for a period of less than three weeks, leave the cooler operating. If the period of inactivity is several months, remove all items and turn the unit off. Clean and dry the interior thoroughly. Leave the door open slightly to prevent and possible moisture build-up.

## PROBLEMS WITH YOUR WINE COOLER

Most common problems can be solved easily, saving you the cost of a possible service call. Try the suggestions below to see if you can solve the problem before contacting Vinotemp at [info@vinotemp.com](mailto:info@vinotemp.com).

### TROUBLESHOOTING

PROBLEM	POSSIBLE CAUSE
Wine cooler does not operate	<ul style="list-style-type: none"> <li>• Ensure cooler is plugged in to electrical outlet</li> <li>• Check voltage level</li> <li>• Check for broken fuse</li> </ul>
Wine cooler is not cold enough	<ul style="list-style-type: none"> <li>• Ensure temperature control is at a proper setting</li> <li>• Ensure wine cooler is away from heat sources or direct sunshine</li> <li>• Check for proper clearance on all sides of the wine cooler</li> <li>• Ensure door is properly closed and not open too frequently</li> </ul>
Wine cooler makes too much noise	<ul style="list-style-type: none"> <li>• Ensure cooler is level and on steady surface</li> <li>• Check for proper ventilation and clearance</li> <li>• Check to make sure cooler fans are operating correctly</li> </ul>
Internal light is flashing	<ul style="list-style-type: none"> <li>• Check that selected temperature is not higher than internal cabinet temperature</li> <li>• Automatic defrost function has started. This is a normal function</li> </ul>
Wine cooler has started to frost	<ul style="list-style-type: none"> <li>• Excess humidity or very low temperatures may cause frost to build. Unplug the cooler and allow it to defrost, or defrost by hand</li> </ul>
Door will not close properly	<ul style="list-style-type: none"> <li>• The wine cooler is not level</li> <li>• The doors were not properly installed</li> <li>• The seal is weak</li> <li>• The shelves are out of position</li> </ul>
Light does not work	<ul style="list-style-type: none"> <li>• Call the service center</li> </ul>
Temperature LED display is blank	<ul style="list-style-type: none"> <li>• Main control board does not work</li> <li>• The Power Control Board is not functioning</li> <li>• There is some problem with the plug (no power supply)</li> </ul>
Temperature LED display error	<ul style="list-style-type: none"> <li>• Display has suffered too much wear and tear</li> <li>• Temperature sensor has been cut off</li> </ul>
Buttons are not functional	<ul style="list-style-type: none"> <li>• Temperature controller panel is damaged</li> </ul>
EL light is flashing	<ul style="list-style-type: none"> <li>• EL means the sensor is shut off or dead. Unscrew the fan board behind the shelves and check whether the sensor is connected well. If the sensor is connected well, it means the sensor is dead, then please replace it and check further.</li> </ul>

# TERMS OF SALE AND WARRANTY

Vinotemp International ("Seller") and the person or entity that acquires these goods from Seller ("Purchaser") hereby fully agree to the following terms and conditions of the sale: Shipping fees are the responsibility of the Purchaser whether freight prepaid or freight collect. Seller assumes no responsibility for the goods sold to the Purchaser once the goods have left the Seller's premises, including, but not limited to, late delivery by the moving carrier, or for events caused by any difficulty carrier incurs in attempting to fit the goods into the Purchaser's place of business or residence due to the size of the goods or otherwise. Purchaser assumes all responsibility for delivery, payment of freight, access, measurement, installation, hook-up, wiring, moving and storage of the goods. The transportation of all goods is subject to the terms and conditions which the moving carrier imposes on Purchaser including, but not limited to, additional charges imposed per flight of stairs, and/or additional charges resulting from the carrier's inability to safely and/or adequately use the building elevator to lift the goods to an upper floor. Any claim for damages incurred during shipment by the carrier of the goods are insured and handled directly with the carrier and must be noted at time of delivery. Any damages due to manufacture defects will be handled directly with Vinotemp International, subject to the limited warranty.

All sales are final, and unless authorized in writing by the Seller, Purchaser may not return the goods, under any circumstance. If Purchaser refuses to accept the goods, under any circumstance, the Purchaser is liable for the return and cost of freight both ways, and if Seller does take back the goods, there will be a restocking/service fee that is 35% of the purchase price of the goods. (Product must be in original packaging). Built-to-Order products (including Cabinets, Racking, and Accessories) are non-returnable. Purchaser must notify Seller of non-conforming goods within four days of delivery, after which time all goods are deemed accepted. If an order has been placed and production has started, cancellation of your order will be a 15% charge. If Purchaser tenders payment with a check that has insufficient funds (NSF), or stops payment on a check or credit card for any reason, Purchaser agrees to pay for all costs associated with the Seller's collection or litigation of such a claim, including without limitation extra damages, court costs and attorneys' fees. Finance charges begin the date of invoice. Collection fees plus NSF fee of \$50 will be added to your invoice, which you agree to promptly pay. Title to the goods does not pass until payment is received in full by Seller and Seller retains a security interest in the goods until they are paid for in full. Statute of limitations must be handled in arbitration in the County of Los Angeles.

**LIMITED WARRANTY:** Seller warrants that the goods will be free of defects in materials and workmanship as follows: Furniture style (wood) wine cabinets made in the U.S.: all cooling unit parts for a period of 5 (five) years; cabinetry and labor (uninstalled) for a period of 12 (twelve) months from date of sale. For the metal cabinet wine units: parts and labor for cooling system and cabinetry for a period of 12 (twelve) months from date of sale. Thermoelectric Units: 90 (ninety) days from the date of sale (including Wine Coolers, Beer Dispensers, Humidor, Portofino Wood Cellars, and Refrigerators). Wine-Mate Split Systems and installed products are parts only for 1 year, no labor. Other Wine-Mate Cooling Systems are 5 years parts, 1 year labor. Wine Accessories and Racking Systems are not warranted. There is no warranty on parts purchased separately. Removal and re-installation of unit is not included in warranted labor. Purchaser's exclusive remedy is limited, at Seller's option; to repair or replace defective part[s] with either new or factory reconditioned part[s]. Purchaser is responsible for shipping the unit pre-paid to designated facility and Seller will pay return shipping charges in the continental United States for items repaired under warranty within 12 (twelve) months from date of sale. Since the natural variation in texture, density, grain, color, tone and shade of wood is unavoidable; Seller does not guarantee the texture, color, tone or shade of the wood; nor does seller guarantee the colorfastness of wood or against peeling, chipping, cracking or scratching. Note: Unfinished wood is subject to warping; all wood surfaces must be sealed before placing cellar into service. Improper placement of the unit will void the warranty. By Vinotemp in writing, any third party repair facility must be pre-approved before providing parts free of charge. This limited warranty does not cover damage due to such things as accident, misuse, abuse, mishandling, neglect, acts of God, fires, earthquakes, floods, high winds, government, war, riot or labor trouble, strikes, lockouts, delay of carrier, unauthorized repair, or any other cause beyond the control of the Seller, whether similar or dissimilar to the foregoing. Seller is not responsible for any damages caused to Purchaser's property resulting from the good. This limited warranty applies only inside the Continental US (Alaska, Puerto Rico and Hawaii are not warranted.).

For Non-New Units (Scratch & Dent/Refurbished/Floor Models), warranty for compressor units is 90 days from your dated invoice and 30 days for thermoelectric units (parts for function only, not cosmetic defects). These units are refurbished and sold as is; Purchaser assumes risks to the quality and performance of goods and assumes the costs of all necessary service or repair not covered herein.

For Element Grills (via Element Products LLC), grills have a 1 year comprehensive parts warranty on entire product. Three years limited parts warranty covering the stainless burner and a thirty day limited parts warranty on grill accessories. If grill is defective and unused plus all packaging and parts are intact, we will either replace the grill or provide service to repair the grill. Returned product must accompany all original packaging and parts and is subject to our 35% restocking fee (and freight both ways).

With Wine-Mate products, if the customer calls and the product is "defective", you must obtain a letter from your qualified refrigeration technician at the customers cost, to verify that the unit was installed properly, with proper ventilation and the unit is truly malfunctioning due to manufacture defect.

Purchaser understands and acknowledges that the goods sold here are wine cellars, cigar humidors, and/or other similar units which house wine or cigars. Purchaser assumes all risk of using these units, including risk of spoilage, humidity variations, temperature variations, leaks, fire, water damage, mold, mildew, dryness and similar and any other perils that might occur. Seller is not responsible for incidental or consequential damages, and there are no warranties, expressed or implied, which extend beyond the Limited Warranty described above. Warranty and liability are non-transferable. The implied warranties of merchantability and of fitness for a particular purpose are hereby expressly disclaimed. Some states do not allow the exclusion of incidental or consequential damages, or a waiver of the implied warranties of fitness and/or merchantability, so the above limitations may not apply to you. This warranty gives you specific legal rights and you may also have other rights which vary from state to state. Seller disclaims any indemnification for claims of infringement of any intellectual property of protectable nature. In the event of any dispute between Seller and Purchaser arising out of or relating to these terms and conditions or to the goods sold generally, Purchaser must first file a written claim with Seller within ten days of the occurrence giving rise to the claim and wait an additional thirty days for a response before initiating any legal action. The sale and all terms are subject to California law. Any legal proceeding arising out of or relating to these terms and conditions or to the goods sold generally shall be brought solely and exclusively in the County of Los Angeles. In no event may Purchaser initiate any legal proceeding more than six months after the occurrence of the event giving rise to the dispute.

The above terms and conditions are the only ones governing this transaction and Seller makes no oral representations of any kind. These Terms and Conditions can only be modified in writing, signed by both Purchaser and Seller. 06/13

## SERVICE & IMPORTANT NOTICE

Upon receipt and inspection of unit, the supply cord must be replaced if it is damaged. Contact our customer service at 1-800-777-8466 or [info@vinotemp.com](mailto:info@vinotemp.com).

The manufacturer has a policy of continuous improvement on its products and reserves the right to change materials and specifications without notice.

**WARNING:**  
**Please do not place the unit within reach of children.**  
**For adult use only.**

Contact [info@vinotemp.com](mailto:info@vinotemp.com) with any questions or visit  
**[www.vinotemp.com](http://www.vinotemp.com)**



3069814

CONFORMS TO UL STD.250

CERTIFIED TO CSA STD.C22.2 NO.63-93



17621 S. Susana Road  
Rancho Dominguez, CA 90221  
[www.vinotemp.com](http://www.vinotemp.com)

Vinotemp is a registered trademark of Vinotemp International. All products, features, and services are subject to change without notice. We cannot guarantee the accuracy of the contents of this document. We disclaim liability for errors, omissions, or future changes.

© 2013 Vinotemp International. All rights reserved.