

Vinotemp

WINE-MATE Cooling Unit

Use & Care Manual

VINO1500CD, CTED

VINO2500CD, CTED

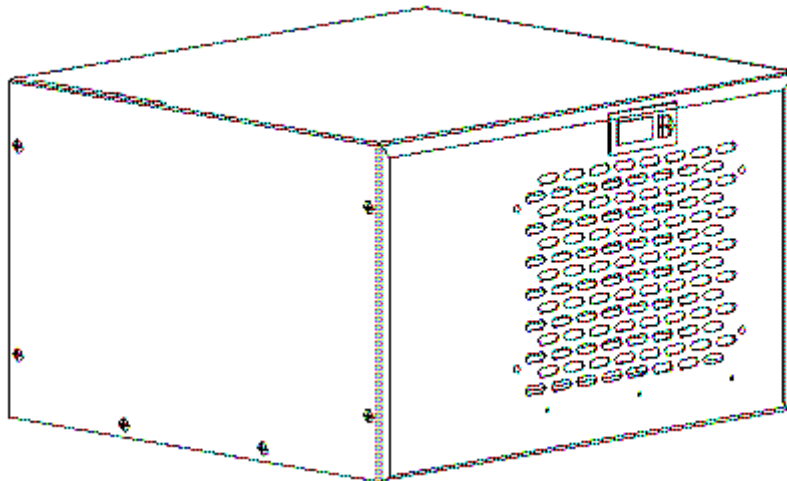

Vinotemp International Corp.

www.vinotemp.com

www.winemate.com

READ AND SAVE THESE INSTRUCTIONS

Important Safety Information

WARNING



To avoid the risk of electrical shock, property damage, personal injury or death:

- The power cord must be plugged into a 3-prong grounding-type wall receptacle, grounded in accordance with the National Electrical Code, ANSI/NFPA 70 - latest edition and local codes and ordinances.
- It is the personal responsibility of the consumer to have a proper 3-prong wall receptacle installed by a qualified electrician.
- **DO NOT, UNDER ANY CIRCUMSTANCES, REMOVE THE POWER CORD GROUNDING PRONG.**
- A separate adequately fused and grounded circuit should be available for this appliance.
- Do not remove any grounding wires from individual components while servicing, unless the component is to be removed and replaced. *It is extremely important to replace all grounding wires when components are replaced.*

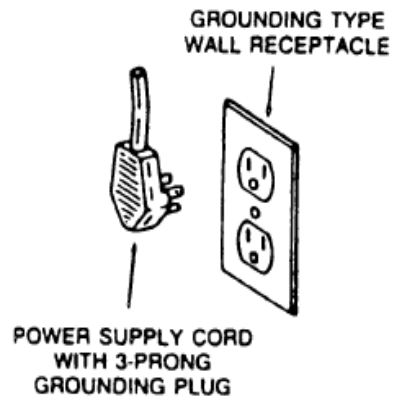

WARNING



ELECTRIC SHOCK HAZARD

- Disconnect electric supply from appliance before servicing.
- Replace all panels before operating.
- Failure to do so could result in death or electrical shock.

- **DO NOT PLUG IN UNTIL 24 HOURS AFTER DELIVERY.**
- **DO NOT USE A GROUND FAULT INTERRUPTER (GFI).**
- **A DEDICATED 20 AMP CIRCUIT IS REQUIRED.**

TABLE OF CONTENTS

Features & Specifications.....	3
Installation Instruction.....	5
Temperature Control & Humidity Adjustment.....	9
Care Guide.....	12
Troubleshooting.....	13
Wiring Diagram.....	16
Customer Support.....	17
Warranty.....	18

Features and Specifications

- VINO1500CD, CTED and VINO2500CD, CTED cooling units are designed and used to provide a subtle temperature between 50~65 °F for suitable space at a normal environment.
- The refrigerated space will maintain humidity of 50~70% RH even when the environment becomes dry and humid.
- These temperatures and humidities are optimized for long term storage of wine.
- Bottom cold-air supply is optimized for use in the wine cabinets.
- Multiple options for top and rear hot air exhaust
- Self-contained ready for use and easy for installation

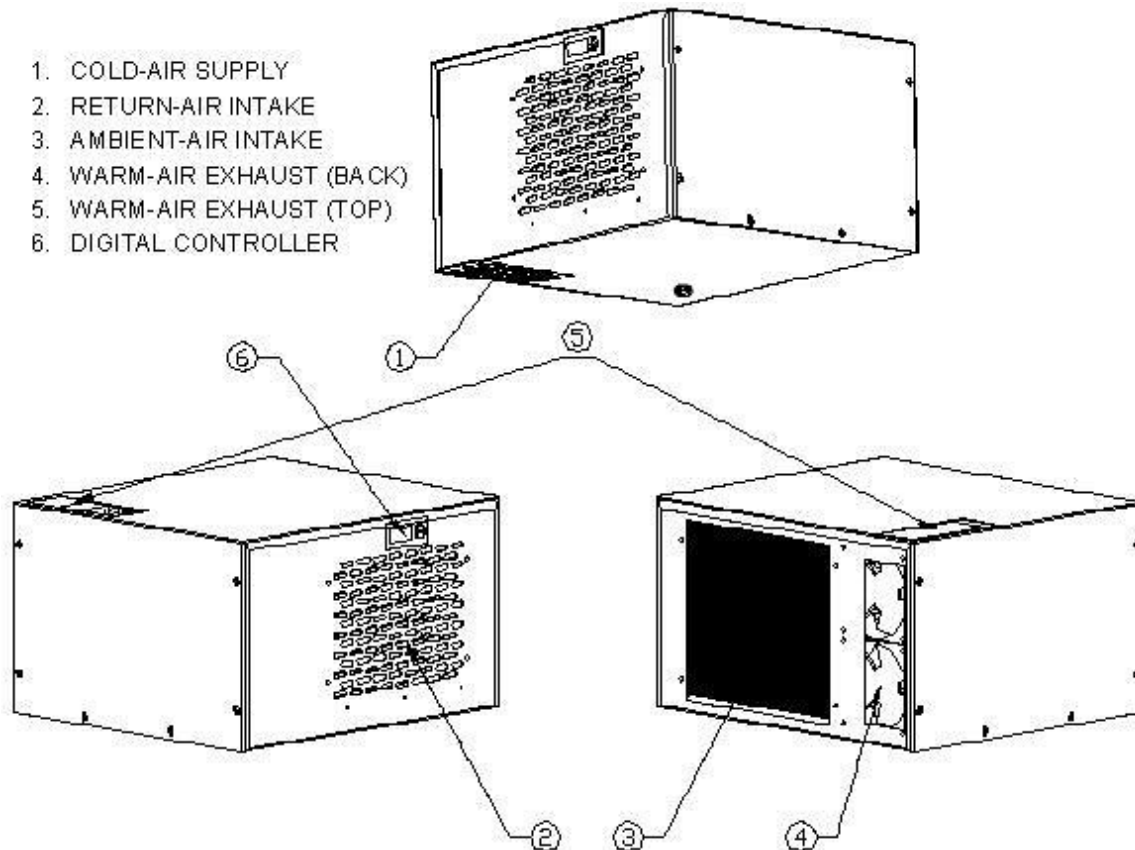

Fig. 1.1 FEATURES

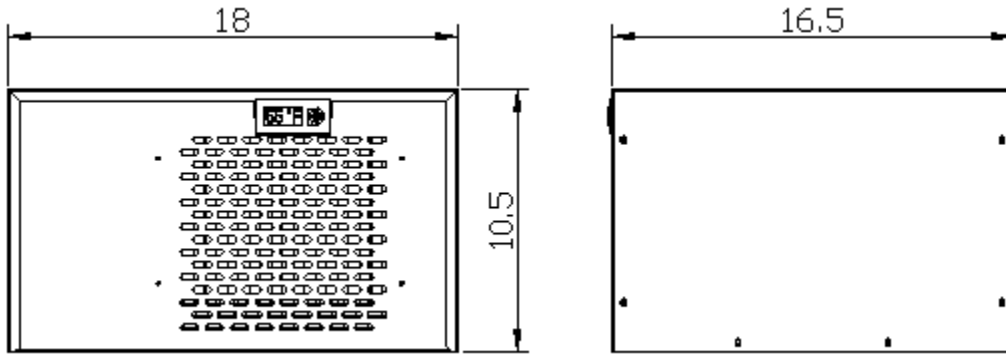

Fig. 1.2 DIMENSIONS (in)

The dimension and capacity are specified as follows:

Model	Exhaust	CFM	Capacity cu ft (55°F/75°F)	Electrical	Weight (lb)
1500cd	Rear Exhaust	120	90	115V/60Hz/4A	50
1500cted	Top Exhaust	120	90	115V/60Hz/4A	50
2500cd	Rear Exhaust	180	200	115V/60Hz/5A	55
2500cted	Top Exhaust	180	200	115V/60Hz/5A	55

NOTES:

- See the voltage, frequency and current specified on the label at the cooling unit.
- Capacity is determined under the cabinet and ambient temperatures of 55°F and 75°F with R11 interior and R19 exterior insulations. Any lower cabinet and higher ambient temperatures will reduce the capacity.

Installation Instruction

NOTES:

- 1) **DO NOT INSTALL ANY DUCTS ONTO THE SUPPLY, INTAKE AND EXHAUST.**
- 2) **MOUNTING BRACKETS, SCREWS, GASKETS AND OTHER SEAL MATERIALS ARE NOT INCLUDED.**
- 3) **THERE IS A GROMMET ON THE POWER CORD. PRESS AND FIT THE GROMMET INTO THE HOLE AT THE BOTTOM OF THE COOLING UNIT TO SEAL THE EXHAUST AIR NOT GOING TO THE CABINET.**

1. Cabinet Location

- Place the wine cabinet in a properly ventilated location. Otherwise, heat exhausted by the cooling unit will build up and it will not operate properly.
- The exhaust area must not be a closed space and must be ventilated. The ambient temperatures shall not be higher than 78°F for a VINO-1500CD unit and 95°F for a VINO-2500CD unit or lower than 50 °F.

1) Rear Exhaust Location

- Leave min 6 "clearance from the rear to the wall.
- Leave min 12" clearance from the top to the ceiling.
- Leave min 6" clearance from the left and right sides.

2) Front Exhaust Location

- Leave min 6" clearance from the front if left and right sides unobstructed.
- Or, leave min 36" clearance from the front if left and right sides obstructed

3) Top Exhaust Location

- Leave min 12" from the top to the ceiling.
- Leave min 2 "clearance from the rear to the wall.
- Leave min 2" clearance from the left and right sides.

4) Side Exhaust Location

- Leave min 6 "clearance from the left or right side to the wall.
- Leave min 12" clearance from the top to the ceiling.

2. Cooling Unit Installation

- The cooling unit produces cooling supplied into the cabinet, and it also generates heat that must be exhausted outside the cabinet. So the cold supply side and hot exhaust side must be separated and sealed (see Fig. 2.1). Foam tape may be used to seal them. The cooling unit must intake adequate fresh ambient-air to work properly. The ambient-air intake and warm-air exhaust must not be short-circulated. A piece of wood may be used to separate them.

- Cut a rectangular inside opening at the rear of the cabinet with the 1/4" clearance inwards to the width and height of the cooling unit. By not going through, leave 1/2" lip inside at the wall to place the gaskets (see Fig. 2.2).
- If top exhaust, cut another rectangular opening at the top of the cabinet to the length and width of the top exhaust (see Fig.2.2).
- Make 2 holes at the ceiling to install the 1/4 inside diameter wood thread inserts (see Fig.2.2).
- Place the gaskets (1/2" foam tape) on the gasket lips (see Fig 2.1).
- If top exhaust, place another gaskets along the top exhaust at the top of the cooling unit (see Fig.2.3).
- Move the cooling unit towards the mounting sides and push to press the gaskets.
- Fasten the 2 brackets and use 7/16" wrench to tighten the two 1/4" screws (see Fig 2.1).
- Attach the exhaust and fresh air grille with screws from the rear side of the cabinet.
- If top exhaust, install another top exhaust grille at the top of the cabinet.
- Plug the cooling unit in receptacle.
- Plug the wine cabinet.

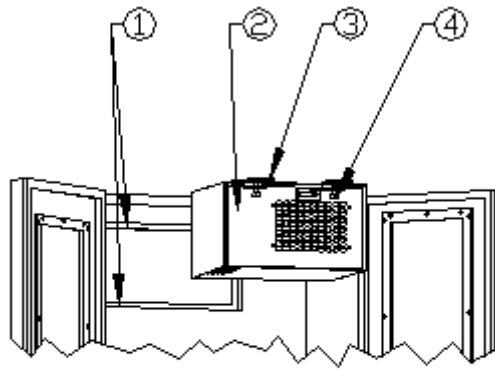

1. GASKET
2. COOLING UNIT
3. MOUNTING BRACKET
4. MOUNTING SCREW

Fig. 2.1 COOLING UNIT MOUNTING

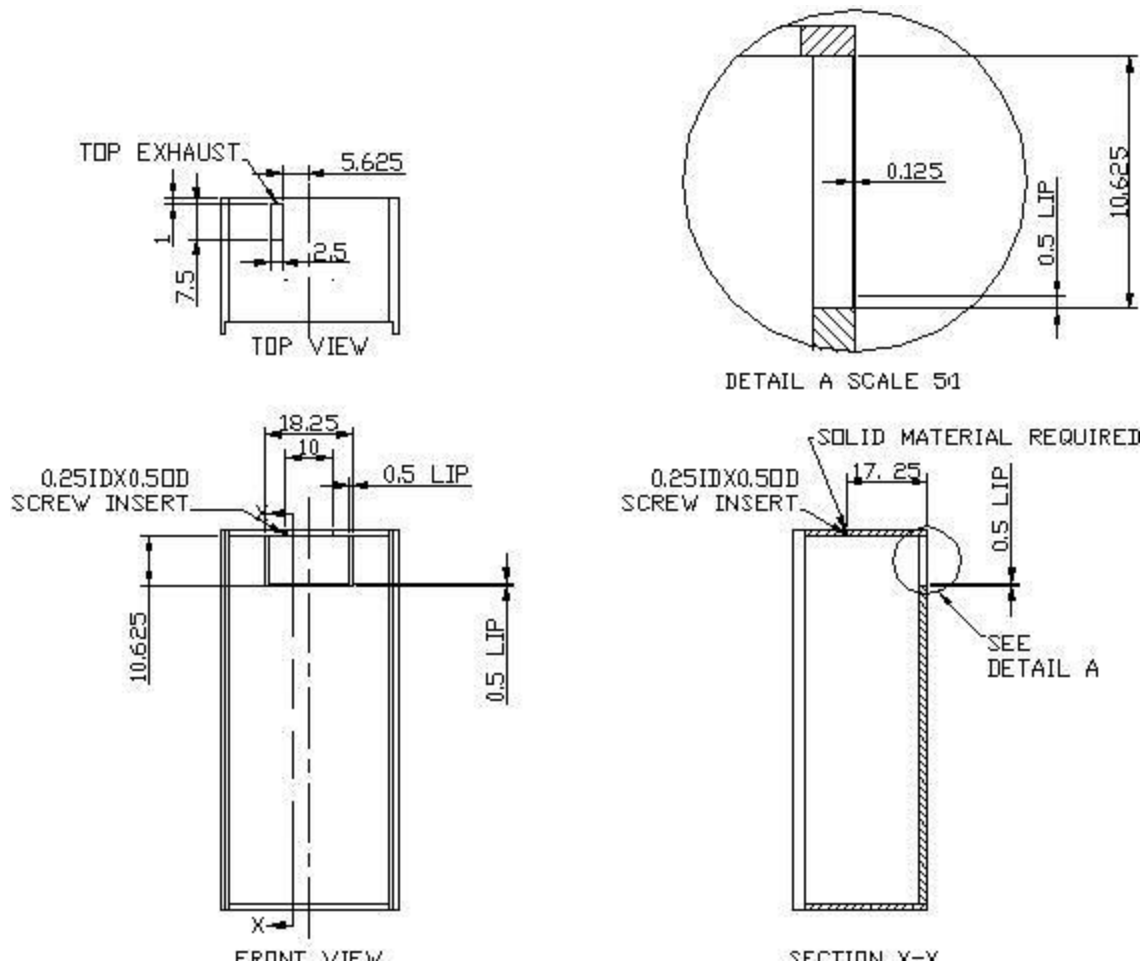

Fig. 2.2 MOUNTING CUTOUT & GASKET LIPS

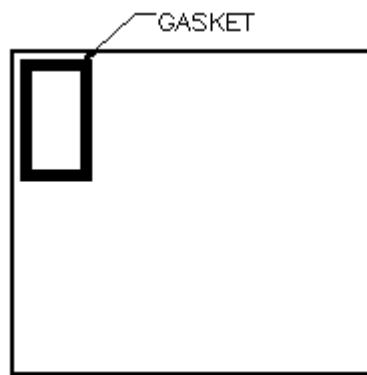

Fig. 2.3 TOP EXHAUST GASKET

2. Electrical Cord

- We strongly recommend against the use of an extension cord. However, if you still select to use an extension cord, it is absolutely necessary that it is a UL LISTED 3-wire grounding type appliance extension cord. The marked rating of the extension cord shall be 115 V, 15 A. or equivalent and not greater than 15ft in length.

Temperature Control & Humidity Adjustment

1. Temperature Setting

- Set the temperature at 55 °F for the optimum aging of wine
- On initial start-up, the time required to reach the desired temperature will vary, depending on the quantity of bottles, temperature setting and surrounding temperature.
- Allow 24 hours to stabilize the temperature for each new temperature setting operation

2. Use of the controller



Fig. 3.1 Temperature Controller

1) Keys

SET: To display target set point; in programming mode it selects a parameter or confirm an operation.

❄️(DEF): To start a manual defrost.

▲(UP): To see the maximum stored temperature; in programming mode it browses the parameter codes or increases the displayed value.

▼(DOWN): To see the minimum stored temperature; in programming mode it browses the parameter codes or decreases the displayed value.

⏻: To turn on/off the power to the unit.

▲+ ▼: To lock/unlock the keypad.







SET+ ▼: To enter in the programming mode.

SET+ ▲: To return to the temperature display.

2) Display

During normal operating conditions, the display shows the value measured by the air regulation probe. In case of active alarm, the temperature flashes alternately to the code alarm.

2.1 LED Functions

LED	MODE	FUNCTION
	ON	Compressor enabled
	Flashing	Anti-short cycle enabled
	ON	Defrost cycle enabled
	ON	Fan enabled
	Flashing	Fan delay after defrost enabled
	ON	Alarm occurring
°C/°F	ON	Temperature measuring unit
°C/°F	Flashing	Programming mode

3) Alarm Signals

3.1 Code Description

MESSAGE	CAUSE	FUNCTION
P1	Temperature probe faulty	Compressor switching to Con and CoF
HA	High temperature alarm	Outputs unchanged
LA	Low temperature alarm	Outputs unchanged
CA	External alarm	All outputs off

3.2 Alarm Recovery



Probe alarms P1”, start a few seconds after the fault in the related probe; they automatically stop a few seconds after the probe restarts normal operation. Check connections before replacing the probe. Temperature alarms “HA”, “LA” automatically stops as soon as the temperature returns to normal value. Alarm “CA” (with i1F=PAL) recovers only by switching off and on the instrument.

4) Temperature Set-Point







4.1 How to see the set-point

1. Press and immediately release the **SET** key, the display will show the set-point value.
2. Press again and immediately release the **SET** key or wait for 5 seconds to display the probe value again.

4.2 How to change the set-point

1. Press the **SET** key for more than 3 seconds until the “°C” or “°F” LED starts blinking and the set-point will be displayed.
2. To change the set value, press the up/down keys / within 10 sec.
3. To store the new set-point value, press the **SET** key again or wait 10 sec.

5) Parameter Programming

1. Press the **SET** +  keys for 3 sec until the “°C” or “°F” LED starts blinking, then release the keys.
2. Press again the **SET** +  keys for more than 7sec until the **Pr2** label will be displayed, then release the keys. The first parameter **Hy** will be displayed.
3. Press up/down keys / to select the required parameter within 10 sec.
4. Press the “**SET**” key to display its value.
5. Use up/down keys / to change its value within 10 sec.
6. Press “**SET**” to store the new value.
7. **To exit:** Press **SET** +  or wait 15sec without pressing a key.

PARAMETER	DESCRIPTION	VALUE
Set	set-point (°)	55
Hy	temperature regulation differential (°)	4
AC	anti-short cycle delay (min)	10
Con	compress on with probe faulty (min)	15
CoF	compress off with probe faulty (min)	30
CF	temperature unit (°F/°C)	F: Fahrenheit
rES	display resolution	in: integer
dLy	temperature display delay (min)	1
ot	probe calibration (°)	0
US	maximum set-point (°)	65
LS	minimum set-point (°)	50
idF	defrost cycle interval time (hour)	24
MdF	defrost cycle endurance time (min)	30
ALC	temperature alarm type	rE: relative to set-point
ALU	high temperature alarm (°)	10
ALL	low temperature alarm (°)	10
AFH	alarm recovery differential (°)	5
ALd	temperature alarm delay (min)	120
FnC	fan operating mode	C-n: on with compressor & off during defrost
Fon	fan on with compressor (min)	0
FoF	fan off with compressor (min)	15





Note:

- The parameter **Fon** is used to adjust the humidity in the wine cabinet. The higher **Fon** is, the higher relative humidity will be.
- The parameter **FnC = C-y** (on with compressor and on during defrost) with **idF = 8** and **MdF = 15** can be used to defrost more efficiently in case there is much frost.
- The unit turns on at set-point plus regulation differential **Hy** after anti-short cycle **AC** has elapsed and turns off at set-point.

7) Manual Defrost

Press the DEF key for more than 2 seconds and a manual defrost will start.

Care Guide

 WARNING	
	<p>Always check wiring harness connections before initiating any test procedures.</p> <p>Disconnect electric power from the appliance before performing any maintenance or repairs.</p> <p>Voltage checks should be made by inserting meter probes beside the wires in the connector blocks with the electric power source on and the connector block plugged in.</p> <p>Resistance checks should be made on components with the electric power off and the connector block disconnected.</p>
 WARNING	
	<p>ELECTRIC SHOCK HAZARD</p> <p>Disconnect the electrical power before servicing any components. Failure to do so can result in death or electrical shock.</p>

I

I. Condenser Coil Cleaning

- The condenser coil is on the ambient air intake side of the cooling unit.
- Clean the condenser coil regularly. Coil may need to be cleaned at least every 6 months.
- Unplug the cooling unit or disconnect power.
- Use a vacuum cleaner with an extended attachment to clean the coil when it is dusty or dirty.
- Plug the cooling unit or reconnect power.

II. Moisture Removing

- Remove the extra condensate if it is accumulated in the wine cabinet at humidity condition.

Troubleshooting

This Troubleshooting Chart is not prepared to replace the training required for a professional refrigeration service person, not is it comprehensive

Complaint	Possible Causes	Response
1. Unit not running	<ul style="list-style-type: none"> a. Power cord unplugged b. No power to unit c. Setting higher than ambient temperature d. Differential too high e. Incorrect or loose wirings f. Low voltage g. Defrost light blinking h. Compressor light blinking 	<ul style="list-style-type: none"> a. Check for power cord plug b. Check power at receptacle & fuses c. Lower temperature setting d. Decrease the value as to 4 °F e. Check all wirings and connections f. Contact an authorized electrician g. Unit is under defrost mode h. Unit waits for anti-short cycle delay
2. Cabinet temperature high, unit stopping and starting with short running time	<ul style="list-style-type: none"> a. air sensor touching the evaporator coil, displaying temperature ok b. Short circuit of air flow between supply and return air c. Setting too high d. Failed temperature controller and thermistor 	<ul style="list-style-type: none"> a. Move the air sensor away from the evaporator b. Deflect the supply air down c. Lower setting d. Call service for diagnosis
3. Temperature high, compressor stopping and starting but very short running time	<ul style="list-style-type: none"> a. Incorrect voltage b. Failed thermistor c. Failed components d. Improper condenser airflow e. Dirty condenser f. Overcharge of refrigerant g. Discharge or suction pressure too high 	<ul style="list-style-type: none"> a. Check for voltage b. Check thermistor by placing it in ice water and measuring resistance c. Check compressor windings, start relay and overload protector. d. Check for condenser fan e. Clean condenser f. Call service for removing refrigerant g. Call service for OEM information
4. Temperature high or not cooling and running continually; "HA" alarm blinking and beeping	<ul style="list-style-type: none"> a. Improper room insulation & seal b. Room too large c. Ambient temperature too high d. Exhaust restricted e. Malfunctioning fans f. Improper evaporator or condenser airflow g. Dirty Condenser h. Iced evaporator i. Refrigeration system restriction j. Refrigerant leak k. Undercharge or overcharge 	<ul style="list-style-type: none"> a. Check for insulation, gasket and door opening b. Check for excessive size c. Check for installation location d. Leave minimum required clearance for the exhaust side and leave minimum required clearance for the fresh air intake side e. Check for both evaporator and condenser fans f. Check for air restrictions, air short-circulation, grille directions g. Clean condenser h. Defrost and reset temperature i. Call service for checking restrictions j. Call service for checking loss of refrigerant k. Call service to add or remove refrigerant

	<ul style="list-style-type: none"> i. Failed components 	<ul style="list-style-type: none"> i. Check compressor windings, start relay and overload protector
5. Unit running too long	<ul style="list-style-type: none"> a. Improper room insulation & seal b. Exhaust restricted c. Room too large d. Ambient temperature higher > 90°F e. Dirty Condenser 	<ul style="list-style-type: none"> a. Check for insulation, gasket and door opening b. Leave minimum required clearance for the exhaust side and leave minimum required clearance for the fresh air intake side c. Check for excessive size or increase setting d. Check for installation location or increase setting e. Clean condenser
6. Fan motor running but compressor not running	<ul style="list-style-type: none"> a. Post-compressor fan running mode b. Incorrect power supply c. Incorrect or loose wirings d. Failed components e. Liquid refrigerant in the compressor 	<ul style="list-style-type: none"> a. Check for fan running time FON b. Check for proper voltage c. Check all wirings and connections d. Check start relay, start capacitor, overload protector, compressor. e. Call service for OEM information.
7. Compressor running but fan not running	<ul style="list-style-type: none"> a. Fan blade stuck b. Incorrect or loose wirings c. Failed motors 	<ul style="list-style-type: none"> a. Check for proper clearance b. Check all wirings c. Call service for checking open or shorted windings
8. Temperature fluctuating	<ul style="list-style-type: none"> a. Air sensor 	<ul style="list-style-type: none"> a. When using an air sensor, the wine bottle temperature is mainly controlled by the average air temperature. If the set-point is 55°F with the differential 4F, the cooling unit turns on at 59°F of air temperature and turns off at 55°F of air temperature. The average air temperature is 57°F, and then the wine temperature is around 57+/-0.5°F. The air is light enough to change so quickly that it maintains relatively constant average temperature that would prevent wine bottle temperature from fluctuating.
9. Fan running too long	<ul style="list-style-type: none"> a. Post-compressor fan running mode for humidity modulation 	<ul style="list-style-type: none"> a. Reset FON
10. Unit not starting , but temperature rising high	<ul style="list-style-type: none"> a. Anti-short cycle 	<ul style="list-style-type: none"> a. Reset AC

11. Evaporator freezing up	<ul style="list-style-type: none"> a. Evaporator air flow restriction b. Not stopping due to air leak, high ambient temperature or low setting c. Low ambient temperature d. Bad thermostat or sensor e. Moisture in the system f. Refrigerant low or leaking g. Capillary tube blockage 	<ul style="list-style-type: none"> a. Check for fans & CFM b. Check for seal, door opening, ambient temperature and setting c. Defrost unit d. Check for thermostat and sensor e. Works initially then stops; Call service. f. Call service to check for current and sealed system leakage g. Call service to check for capillary frost
12. Water leak	<ul style="list-style-type: none"> a. Air leak in wine cellar b. Evaporator air flow restriction c. Water passages restricted d. Drip tray leak e. High humidity 	<ul style="list-style-type: none"> a. Check for any air leak b. Check air flow or air TD crossing evaporator c. Clean the drip tray d. No water overflow but leak e. Use drain line
13. Circuit tripping	<ul style="list-style-type: none"> a. Incorrect fuse or breaker b. Incorrect wirings c. Failed components 	<ul style="list-style-type: none"> a. Check for proper fuse or breaker b. Check for wirings and connections c. Call service
14. Noisy operation	<ul style="list-style-type: none"> a. Mounting area not firm b. Loose parts c. Compressor overloaded due to high ambient temperatures or airflow restriction d. Malfunctioning components 	<ul style="list-style-type: none"> a. Add support to improve installation b. Check fan blades, bearings, cabinet washers, tubing contact and loose screws. c. Check for airflow blockage d. Call service for checking internal loose, inadequate lubrication and incorrect wirings

Wiring Diagram

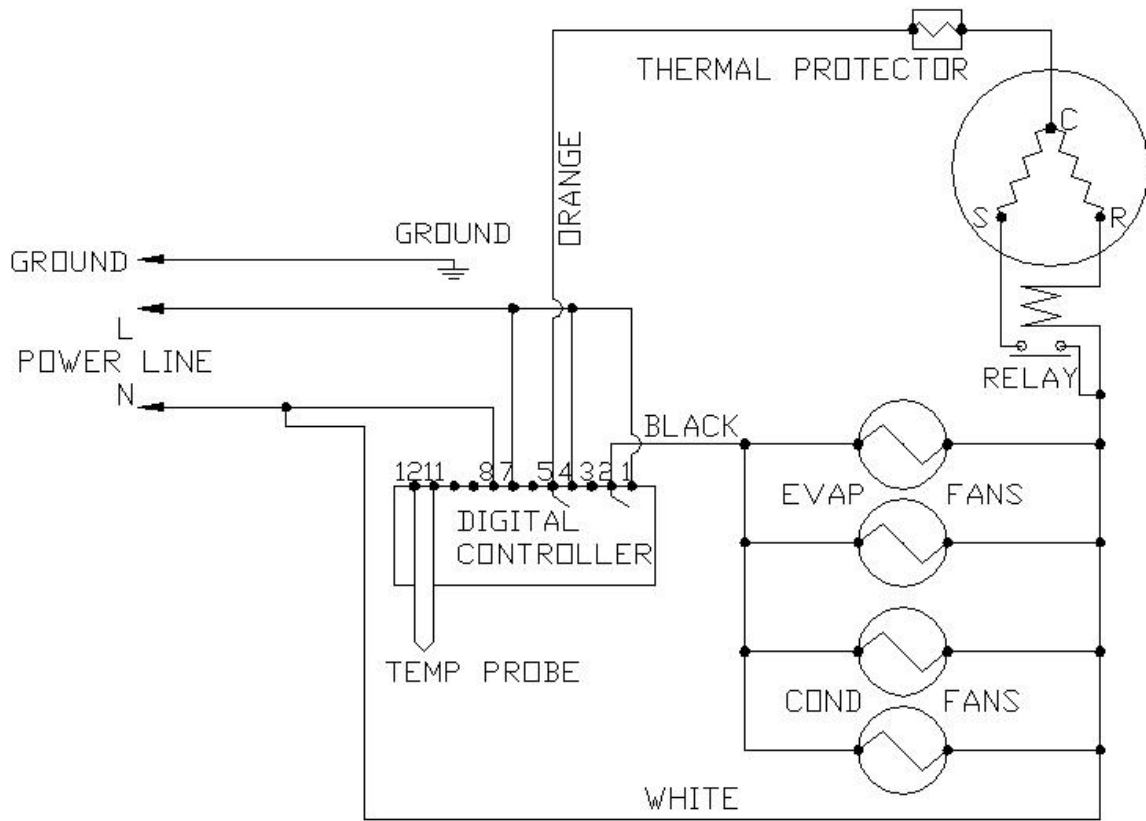

Fig. 6.1 WIRING DIAGRAM

Customer Support

If you still have problems, please contact us at:

Vinotemp International
17631 South Susana Road
Rancho Dominguez, CA 90221
Tel: (310) 886-3332
Fax: (310) 886-3310
Email: info@vinotemp.com

Warranty

Thank you for choosing a Vinotemp cooling unit.

Please enter the complete model and serial numbers in the space provided:

Model _____
Serial No. _____

Attach your purchase receipt to this owner's manual.

1. Limited Warranty

VINOTEMP warrants its products to be free from defects due to workmanship or materials under normal use and service, for twelve months after the initial sale. If the product is defective due to workmanship or materials, is removed within twelve months of the initial sale and is returned to VINOTEMP, in the original shipping carton, shipping prepaid, VINOTEMP will at its option, repair or replace the product free of charge. Additionally VINOTEMP warrants all parts to be free from defects for a period of sixty months after initial sale.

This warranty constitutes the entire warranty of the VINOTEMP with respect to its products and is in lieu of all other warranties, express or implied, including any of fitness for a particular purpose. In no event shall VINOTEMP be responsible for any consequential damages what is so ever. Any modification or unauthorized repair of VINOTEMP products shall void this warranty.

Service under Warranty

This service is provided to customers within the continental UNITED STATES only. VINOTEMP cooling units are warranted to produce the stated number of BTU/H. While every effort has been made to provide accurate guidelines, VINOTEMP can not warranty its units to cool a particular enclosure.

In case of failure, VINOTEMP cooling units must be repaired by the factory or its authorized agent. Repairs or modifications made by anyone else will void the warranty.

Shall a VINOTEMP cooling unit fail, contact the dealer for instructions, do not return the unit to the factory without authorization from VINOTEMP. If the unit requires repair, re-pack it in the original shipping carton and return it to the factory, shipping prepaid. VINOTEMP will not accept COD shipments. If the unit

is determined to be faulty and is within the twelve month warranty period VINOTEMP will, at its discretion, repair or replace the unit and return it free of charge to the original retail customer. If the unit is found to be in good working order, or beyond the initial twelve month period, it will be returned freight collect.

2. Limitation of Implied Warranty

VINOTEMP'S SOLE LIABILITY FOR ANY DEFECTIVE PRODUCT IS LIMITED TO, AT OUR OPTION, REPAIRING OR REPLACING OF UNIT.

**VINOTEMP SHALL NOT BE LIABLE FOR:
DAMAGE TO OTHER PROPERTY CAUSED BY ANY DEFECTS IN THE UNIT,
DAMAGES BASED UPON INCONVENIENCE, LOSS OF USE OF THE UNIT,
LOSS OF TIME OR COMMERCIAL LOSS, ANY OUTER DAMAGES,
WHETHER INCIDENTAL, CONSEQUENTIAL OR OTHERWISE.**

THIS WARRANTY IS EXCLUSIBE AND IS IN LIEU OF ALL OTHER WARRANTIES, EXPRESSED OR INPLIED, INCLUDING BUT NOT LIMITED TO, IMPLIED WARRANTIES OF MERCHANTABILITY OR FITNESS FOR A PARTICULAR PURPOSE.

While great effort has been made to provide accurate guidelines VINOTEMP cannot warrant its units to properly cool a particular enclosure. Customers are cautioned that enclosure construction, unit location and many other factors can affect the operation and performance of the unit. There for suitability of the unit for a specific enclosure or application must be determined by the customer and cannot be warranted by VINOTEMP.